

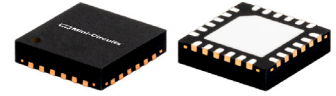

THE BIG DEAL

- Wideband RF & LO, 10 to 30 GHz
- Wideband IF, DC to 7 GHz
- Excellent Image Rejection, Typ. 31 dBc
- High LO-RF Isolation, Typ. 39 dB
- High Input IP3, Typ. +25 dBm
- Usable as Image Reject Mixer & SSB Converter
- 4x4 mm, 24-Lead QFN-Style Package



Generic photo used for illustration purposes only

APPLICATIONS

- Test and Measurement Equipment
- 5G mmWave and Back Haul Radio
- Satellite Communications
- Radar, EW, and ECM Defense Systems

FUNCTIONAL DIAGRAM

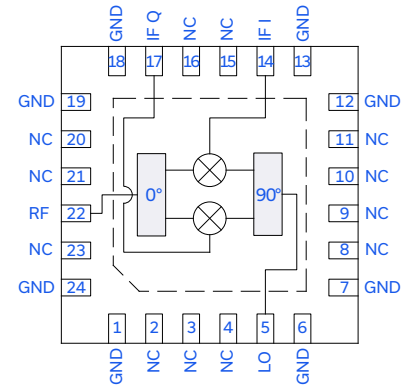

PRODUCT OVERVIEW

The SMIQ-134H+ is a passive wideband in-phase/quadrature (I/Q) mixer fabricated using GaAs HBT technology. The SMIQ-134H+ is usable as a single-sideband upconverter for transmit applications or an image rejection mixer for receiver applications. The SMIQ-134H+ is ideal for wideband frequency translation applications requiring inherent rejection of image signals and spurious mixing products. The mixer covers a broad band with RF and LO frequency ranges of 10 to 30 GHz and an IF frequency range of DC to 7 GHz. As a passive mixer, the SMIQ-134H+ offers a lower noise figure than active mixers, enabling superior dynamic range for high-performance applications. The mixer is housed in a compact 4x4 mm 24-lead QFN-style package, and no DC bias is needed for operation.

KEY FEATURES

Feature	Advantages
High Image Rejection, Typ. 31 dBc	Provides inherent rejection of unwanted image signals without the need for external filtering.
High Isolation, <ul style="list-style-type: none"> • LO-RF, Typ. 39 dB • LO-IF, Typ. 44 dB 	Enables excellent carrier rejection in single-sideband upconverter transmit applications. Minimizes filtering requirements needed to ensure signal integrity.
Wide RF/LO Bandwidth, 10 to 30 GHz	Useful in wideband systems or in reconfigurable narrowband systems across multiple bands with minimal component changes.
Wide IF Bandwidth, DC to 7 GHz	High IF conversion reduces filtering requirements. With IF operation as low as DC this mixer is perfect for phase detector applications.
Small Size, 4x4 mm QFN-Style Package	Tiny footprint saves space in dense layouts, while providing low inductance and repeatable transitions. Industry standard packaging allows for ease of assembly in high volume manufacturing processes.

REV. OR
ECO-022824
SMIQ-134H+
MCL NY
240722



MMIC SURFACE MOUNT

IQ Mixer

SMIQ-134H+

50Ω Level 18 (LO Power +18 dBm) 10 to 30 GHz

ELECTRICAL SPECIFICATIONS¹ AT +25°C, Z₀ = 50Ω, LO POWER = +18 dBm, IF = 200 MHz, UNLESS OTHERWISE NOTED.

Parameter	Frequency (GHz)	Min.	Typ.	Max.	Unit
RF Frequency Range		10		30	GHz
LO Frequency Range		10		30	GHz
IF Frequency Range		DC		7	GHz
LO Power		+17	+18	+19	dBm
Conversion Loss ²	10 - 17		7.5	9.2	dB
	17 - 27		7.4	8.7	
	27 - 30		7.4	9.0	
Amplitude Unbalance	10 - 17		±0.1	±0.5	dB
	17 - 27		±0.1	±0.5	
	27 - 30		±0.1	±0.4	
Phase Unbalance (Relative to 90°)	10 - 17		1	8	deg
	17 - 27		2	10	
	27 - 30		6	11	
Image Rejection ³ (Tested as a Downconverter)	10 - 17		35		dBc
	17 - 27		30		
	27 - 30		26		
Single Sideband Rejection ⁴ (Tested as an Upconverter)	10 - 17		30		dBc
	17 - 27		31		
	27 - 30		21		
LO-RF Isolation	10 - 17	32	41		dB
	17 - 27	31	39		
	27 - 30	33	38		
LO-I Isolation	10 - 17	28	41		dB
	17 - 27	34	50		
	27 - 30	31	40		
LO-Q Isolation	10 - 17	30	39		dB
	17 - 27	36	48		
	27 - 30	40	45		
RF-I Isolation	10 - 17	24	31		dB
	17 - 27	13	24		
	27 - 30	32	39		
RF-Q Isolation	10 - 17	26	34		dB
	17 - 27	18	32		
	27 - 30	40	53		
Input Power at 1dB Compression	10 - 30		+17		dBm
Input IP3 (I) Lower Side Band	10 - 17		+25		dBm
	17 - 27		+25		
	27 - 30		+24		
Input IP3 (Q) Lower Side Band	10 - 17		+25		dBm
	17 - 27		+25		
	27 - 30		+24		





MMIC SURFACE MOUNT

IQ Mixer

SMIQ-134H+

50Ω Level 18 (LO Power +18 dBm) 10 to 30 GHz

ELECTRICAL SPECIFICATIONS¹ AT +25°C, Z_o = 50Ω, LO POWER = +18 dBm, IF = 200 MHz, UNLESS OTHERWISE NOTED.

Parameter	Frequency (GHz)	Min.	Typ.	Max.	Unit
Input IP3 (I) Upper Side Band	10 - 17		+25		dBm
	17 - 27		+25		
	27 - 30		+24		
Input IP3 (Q) Upper Side Band	10 - 17		+25		dBm
	17 - 27		+25		
	27 - 30		+24		

1. Measured on Mini-Circuits Characterization Test Board TB-SMIQ-134HC+. See Figures 2, 3, & 4. Board loss de-embedded to the device.
2. Conversion loss (dB) = RF Power (dBm) minus worse of I/Q Port Power (dBm) minus 3 dB theoretical loss of an Ideal External Hybrid, measured as a Downconverter. See measurement block diagram Figure 2.
3. Level of undesired image signal below desired RF signal. See measurement block diagram Figure 3.
4. Level of undesired sideband below desired sideband. See measurement block diagram Figure 4.



TYPICAL PERFORMANCE GRAPHS

Conversion loss (dB) = RF Power (dBm) minus worse of I/Q Port Power (dBm) minus 3 dB theoretical loss of an Ideal External Hybrid, measured as a Downconverter.

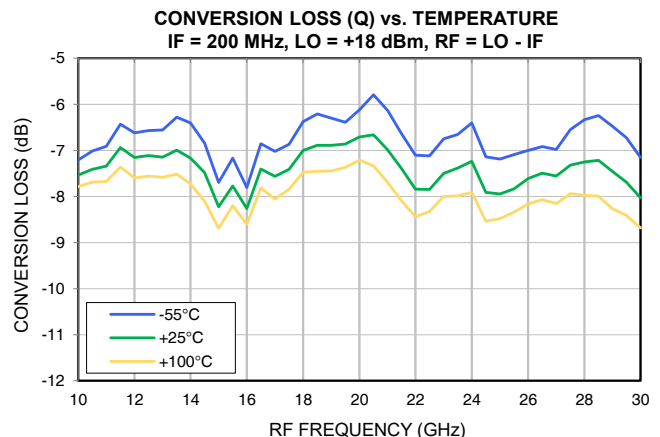
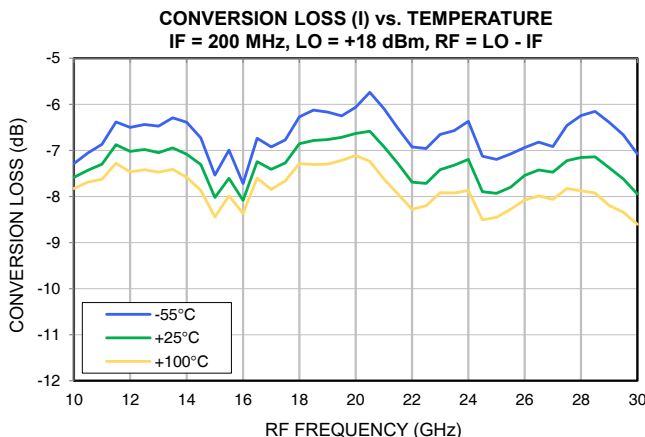
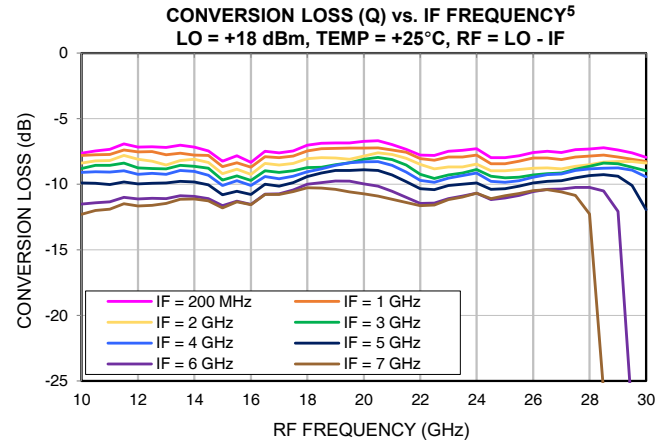
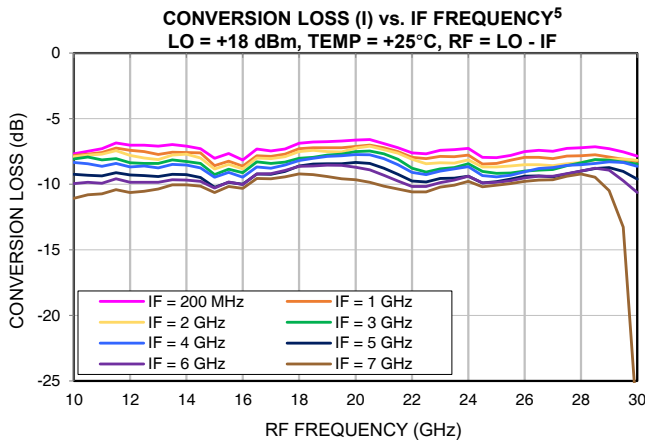
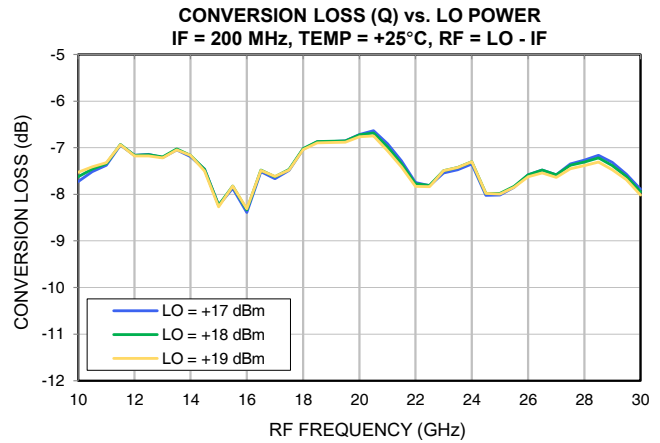
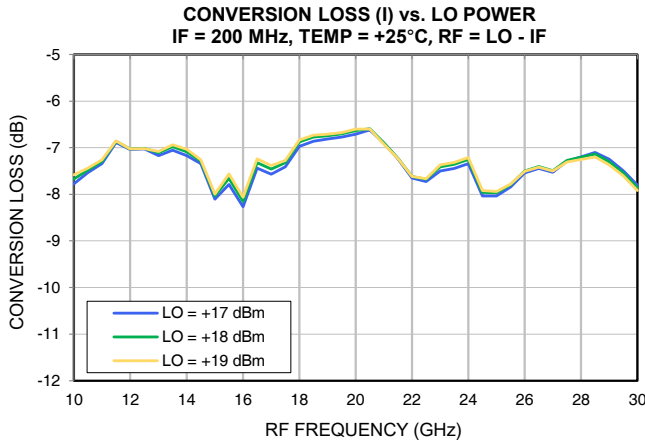

5. Performance degrades when LO is outside of the specified 10 GHz to 30 GHz range.



TYPICAL PERFORMANCE GRAPHS

CONVERSION LOSS (I) vs. LO POWER
LO = 20 GHz, TEMP = +25°C, IF = RF - LO

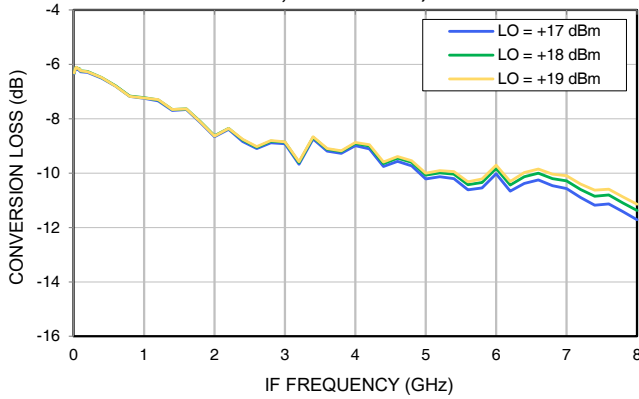

CONVERSION LOSS (Q) vs. LO POWER
LO = 20 GHz, TEMP = +25°C, IF = RF - LO

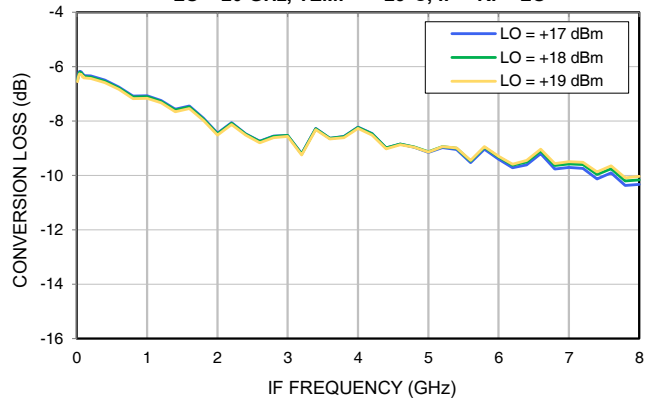

CONVERSION LOSS (I) vs. LO FREQUENCY
LO = +18 dBm, TEMP = +25°C

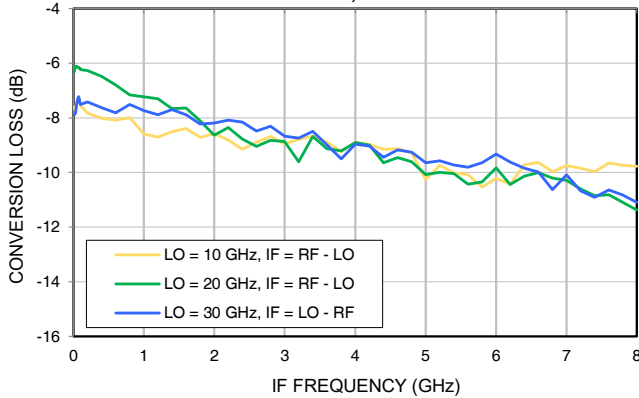

CONVERSION LOSS (Q) vs. LO FREQUENCY
LO = +18 dBm, TEMP = +25°C

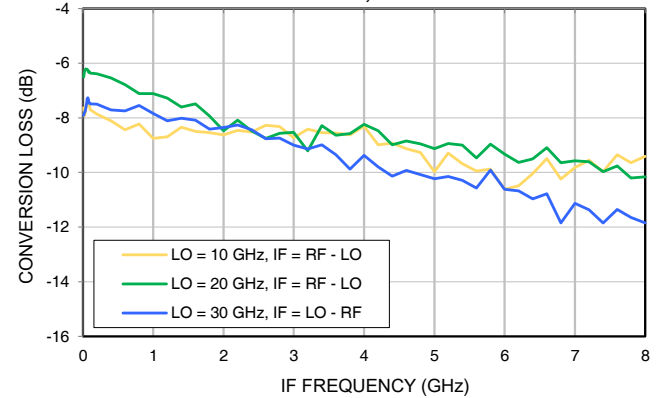

CONVERSION LOSS (I) vs. TEMPERATURE
LO = 20 GHz, LO = +18 dBm, IF = RF - LO

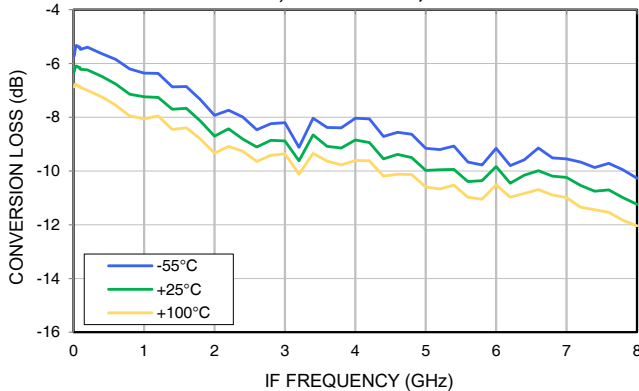

CONVERSION LOSS (Q) vs. TEMPERATURE
LO = 20 GHz, LO = +18 dBm, IF = RF - LO

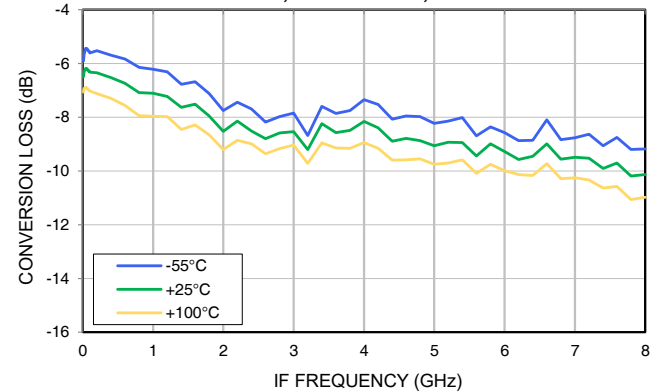



TYPICAL PERFORMANCE GRAPHS

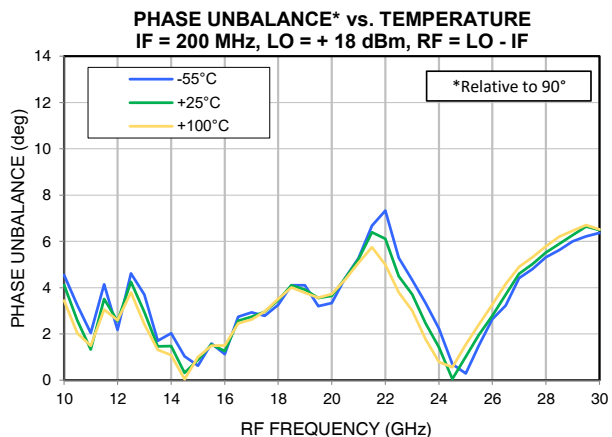
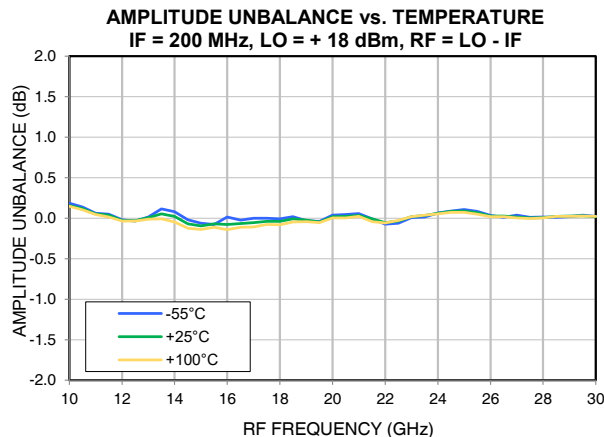
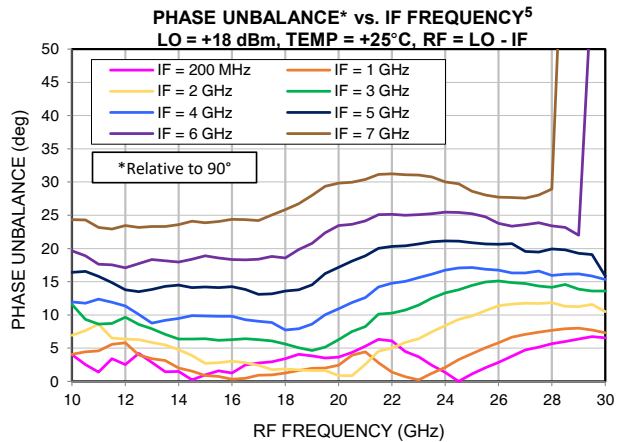
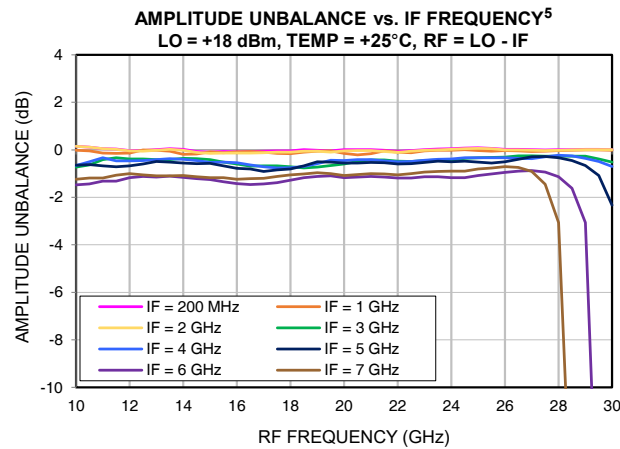
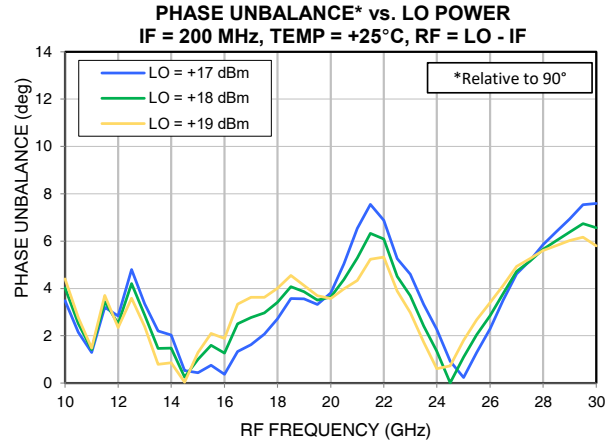
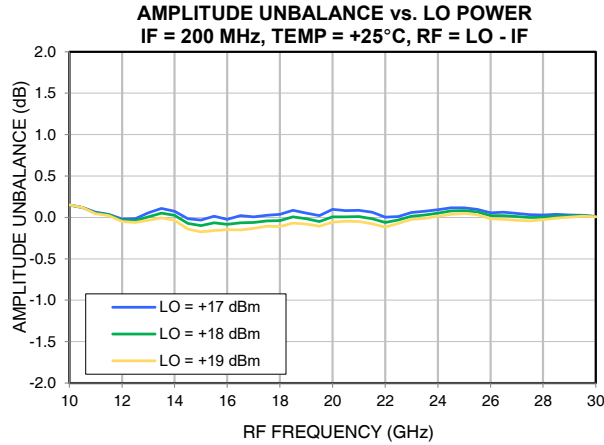

5. Performance degrades when LO is outside of the specified 10 GHz to 30 GHz range.



TYPICAL PERFORMANCE GRAPHS

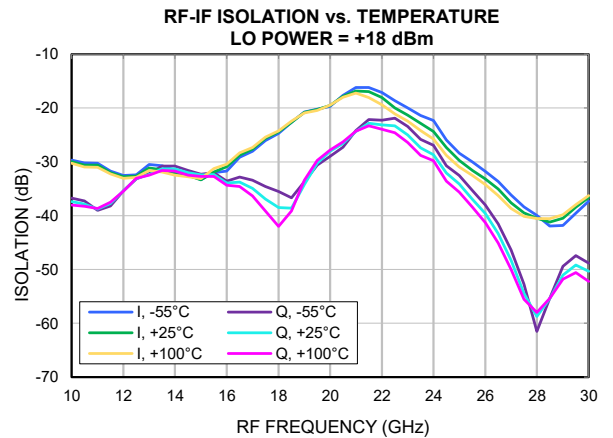
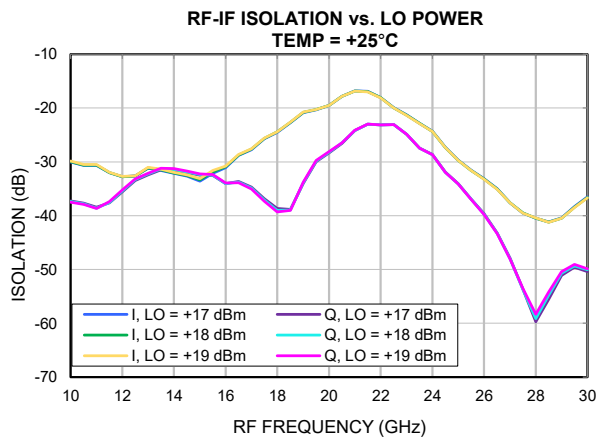
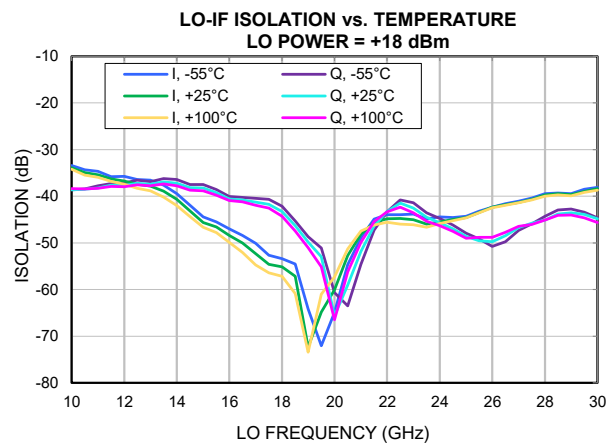
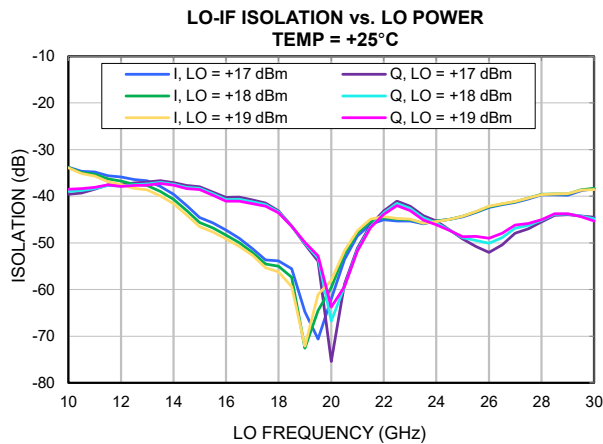
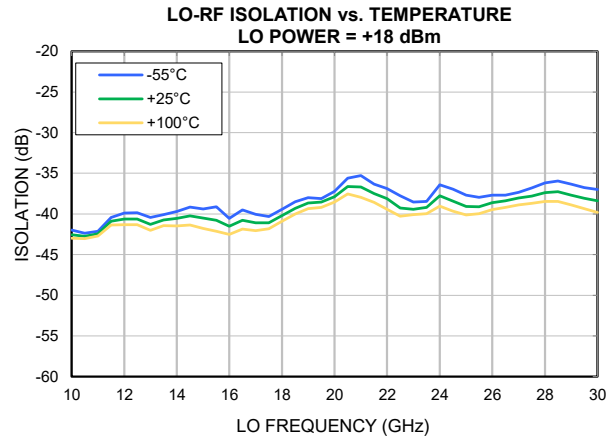
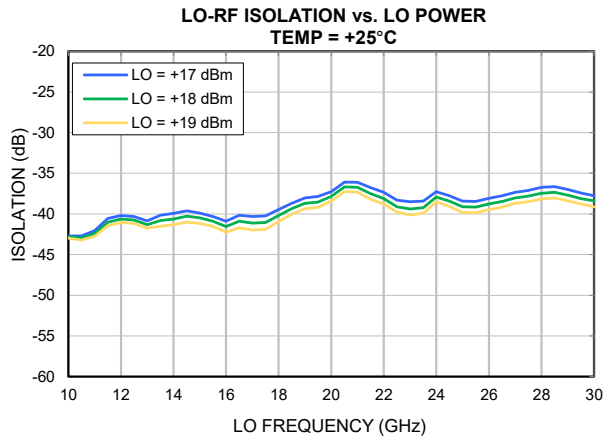



TYPICAL PERFORMANCE GRAPHS

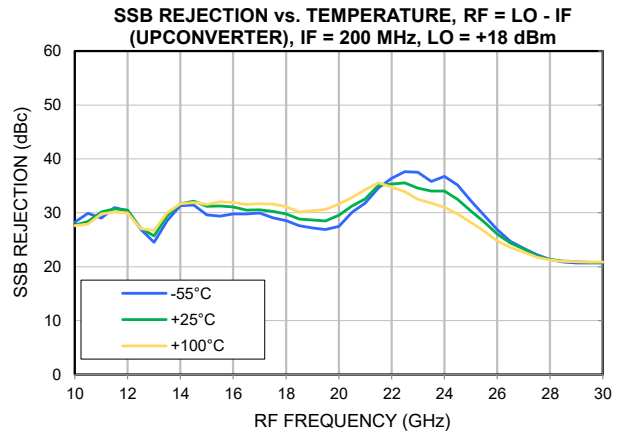
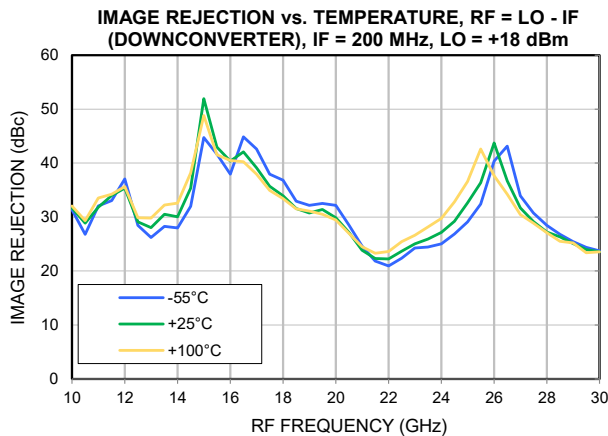
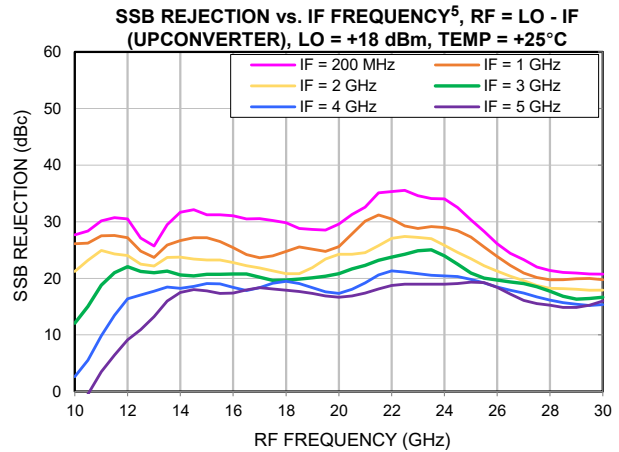
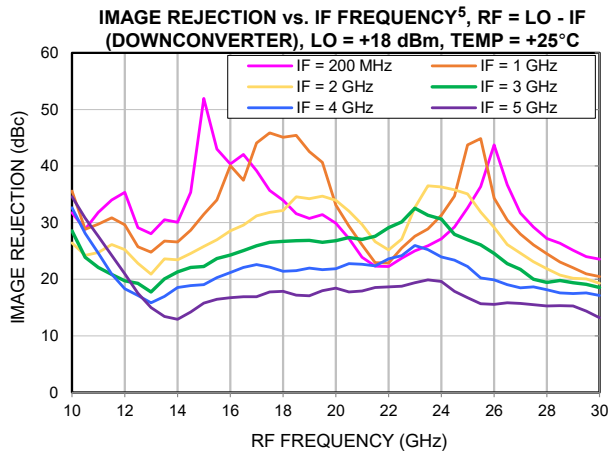
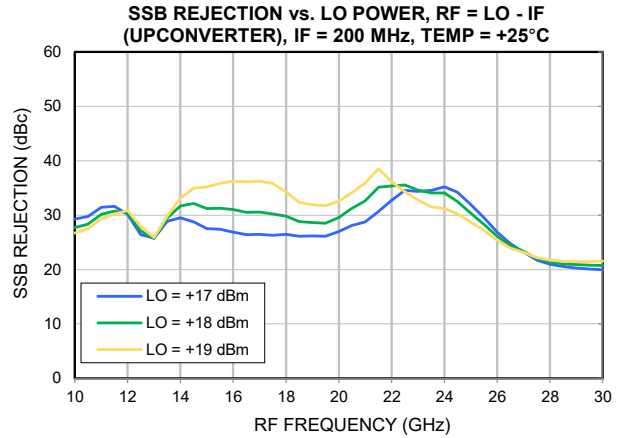
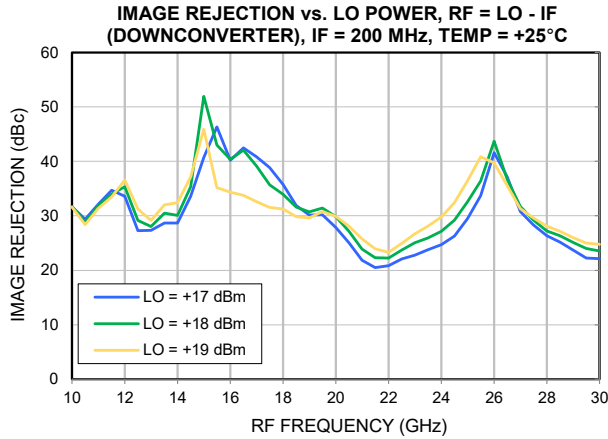

5. Performance degrades when LO is outside of the specified 10 GHz to 30 GHz range.



TYPICAL PERFORMANCE GRAPHS

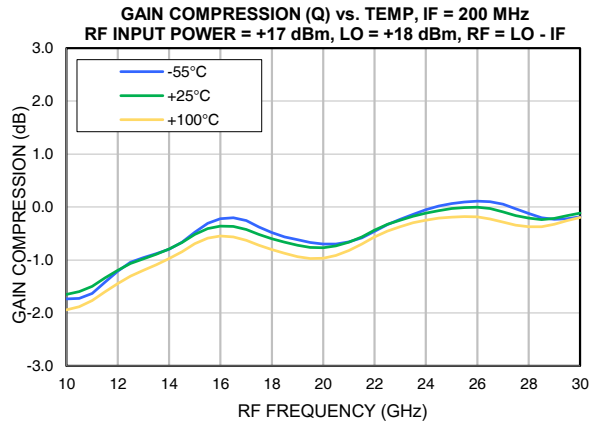
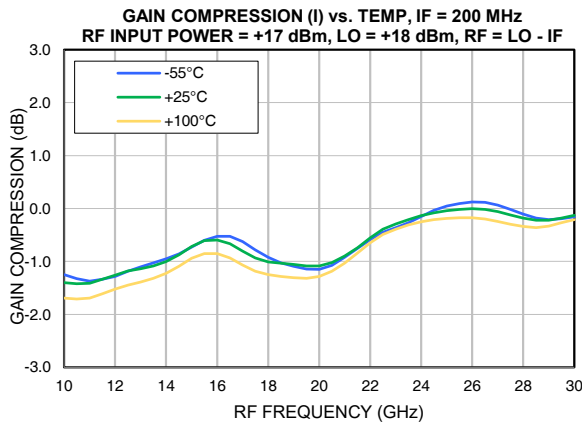
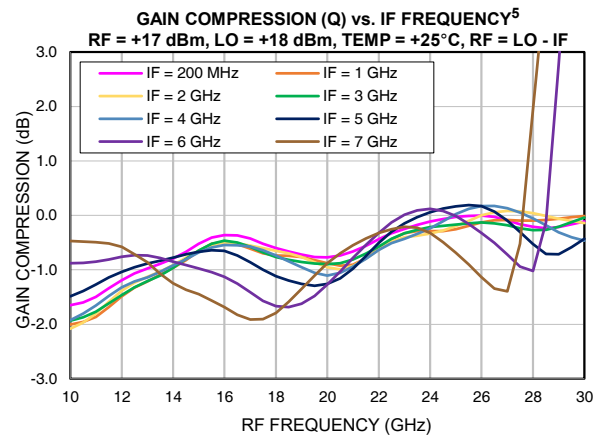
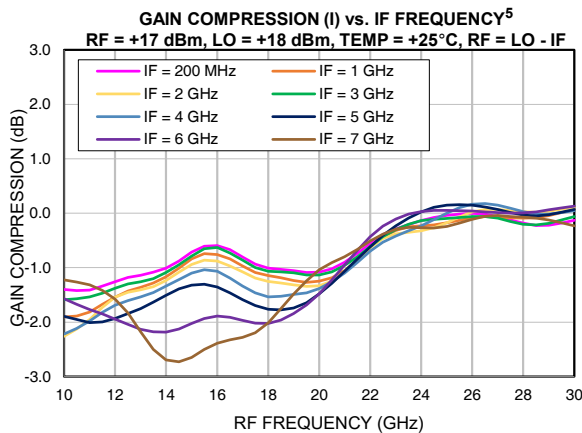
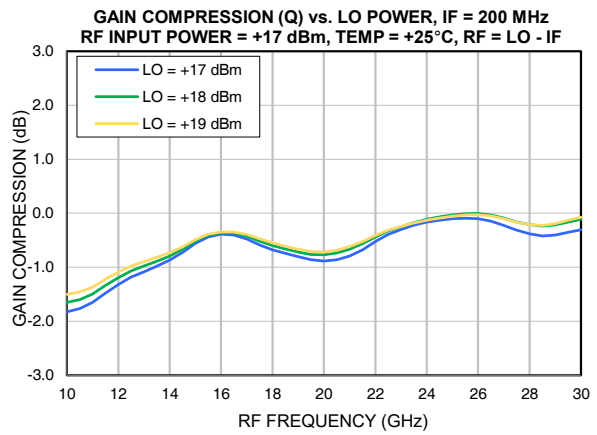
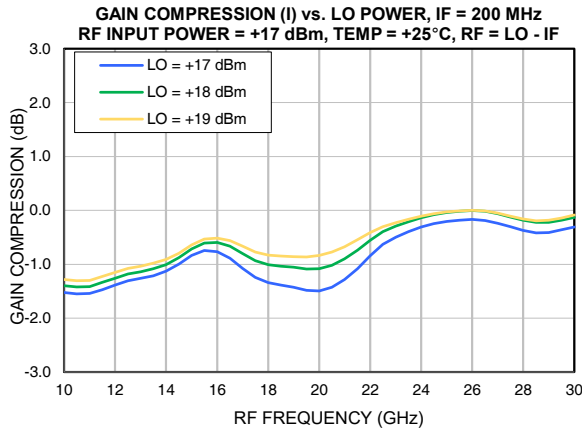

5. Performance degrades when LO is outside of the specified 10 GHz to 30 GHz range.



TYPICAL PERFORMANCE GRAPHS

$P_{IN} = -10$ dBm/Tone with 30 MHz spacing (RF2 = RF1 + 30 MHz)

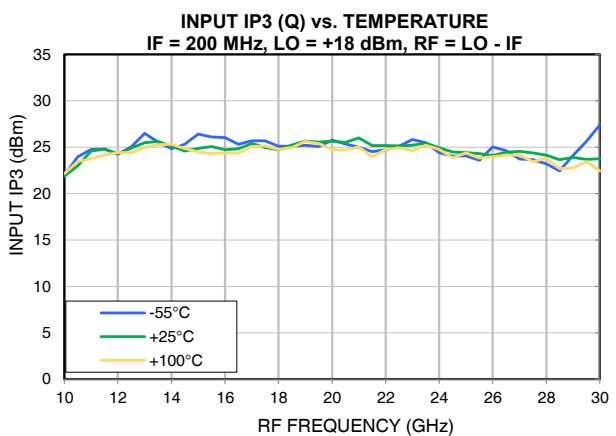
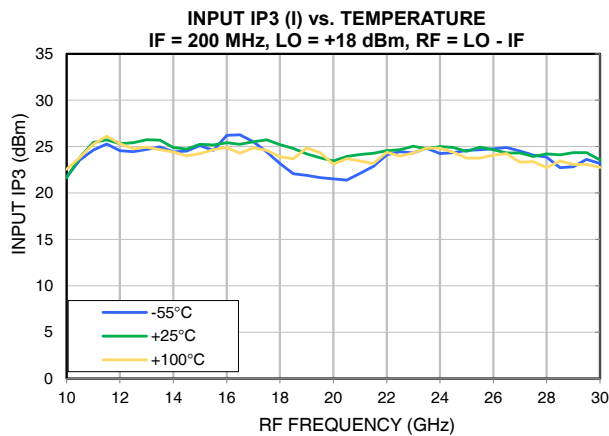
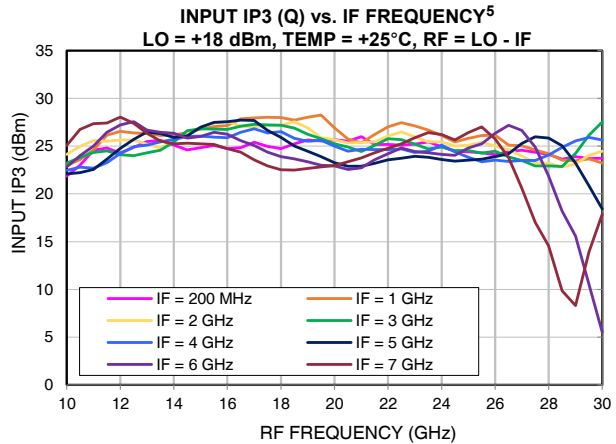
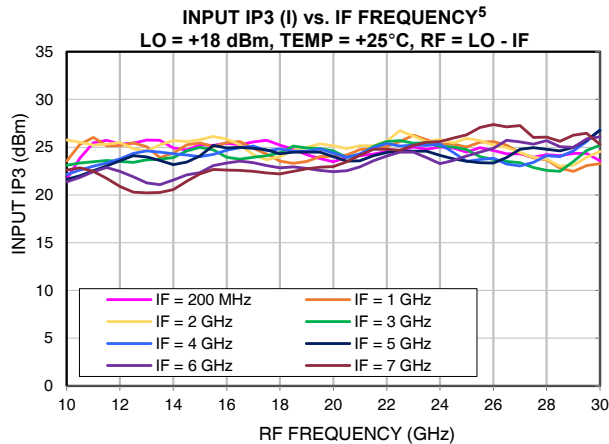
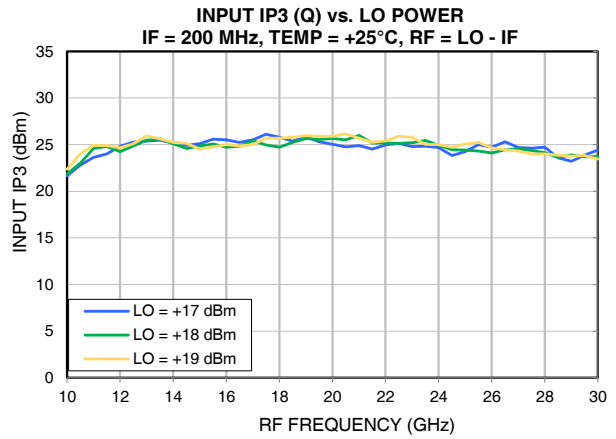
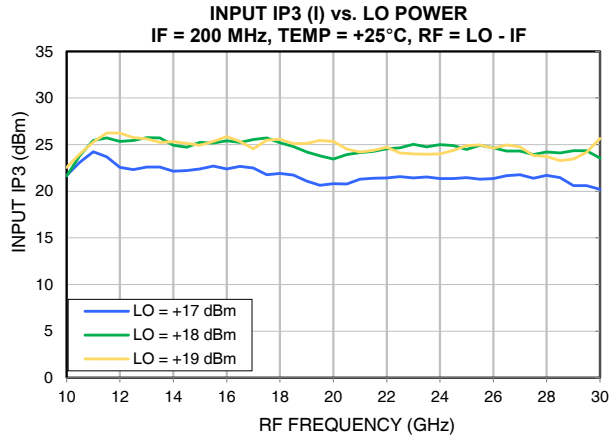

5. Performance degrades when LO is outside of the specified 10 GHz to 30 GHz range.



MMIC SURFACE MOUNT

IQ Mixer

SMIQ-134H+

50Ω Level 18 (LO Power +18 dBm) 10 to 30 GHz

ABSOLUTE MAXIMUM RATINGS⁶

Parameter	Ratings
Operating Temperature	-55°C to +105°C
Storage Temperature	-65°C to +150°C
Junction Temperature	+175°C
RF Power	+24 dBm
LO Power	+24 dBm
I/Q Power	+24 dBm
IF Current	25 mA

6. Permanent damage may occur if any of these limits are exceeded. Electrical maximum ratings are not intended for continuous normal

ESD RATING

	Class	Voltage Range	Reference Standard
HBM	1A	250 to < 500 V	ANSI/ESDA/JEDEC JS-001-2017
CDM	C3	≥ 1000 V	ANSI/ESDA/JEDEC JS-002-2022



ESD HANDLING PRECAUTION: This device is designed to be Class 1A for HBM. Static charges may easily produce potentials higher than this with improper handling and can discharge into DUT and damage it. As a preventive measure Industry standard ESD handling precautions should be used at all times to protect the device from ESD damage

MSL RATING

Moisture Sensitivity: MSL1 in accordance with IPC/JEDEC J-STD-020E /JEDEC J-STD-033C





FUNCTIONAL DIAGRAM

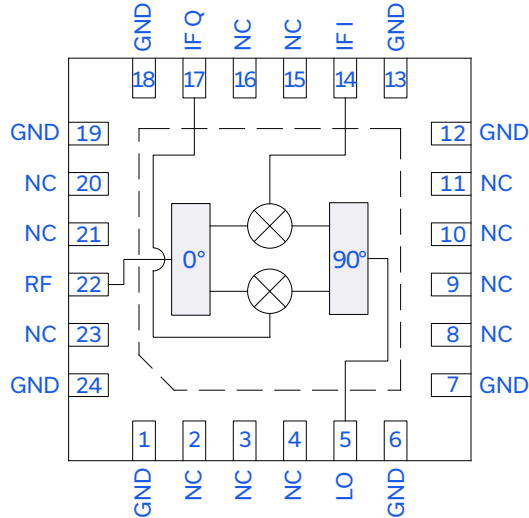

Figure 1. SMIQ-134H+ Functional Diagram

PAD CONNECTIONS

Function	Pad #	Description
RF	22	RF Port. Connects to RF Output for Upconverters or RF Input for Downconverters.
LO	5	LO Port. Connects to LO Input.
IF I	14	IF I Port. Connects to the IF I Input for Upconverters or IF I Output for Downconverters.
IF Q	17	IF Q Port. Connects to the IF Q Input for Upconverters or IF Q Output for Downconverters.
GND	1, 6, 7, 12, 13, 18, 19, 24, Paddle	Connects to ground.
NC	2-4, 8-11, 15, 16, 20, 21, 23	No connection. Grounded on test board.

CHARACTERIZATION TEST CIRCUITS

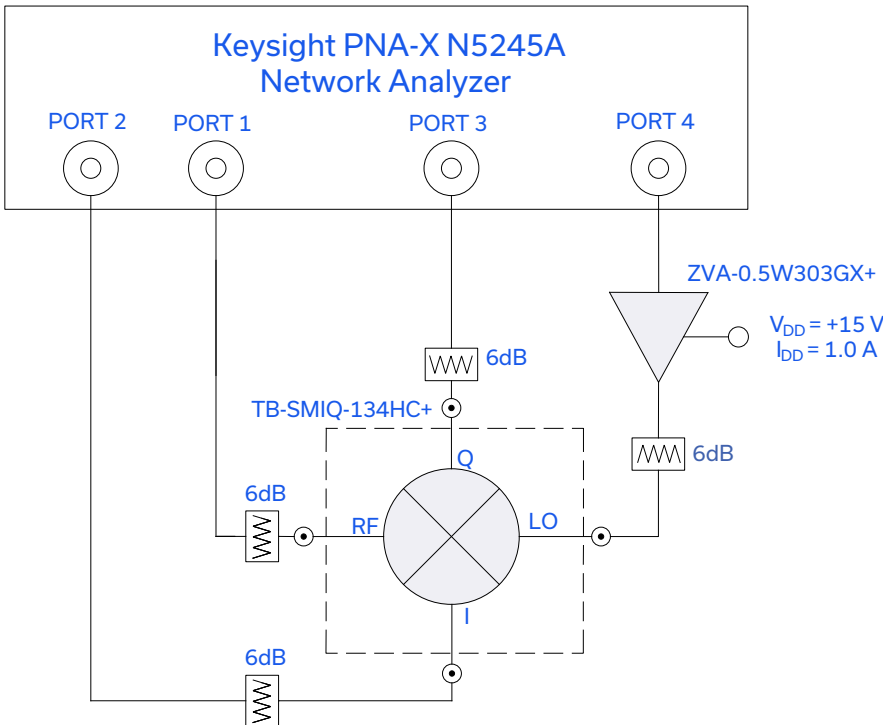
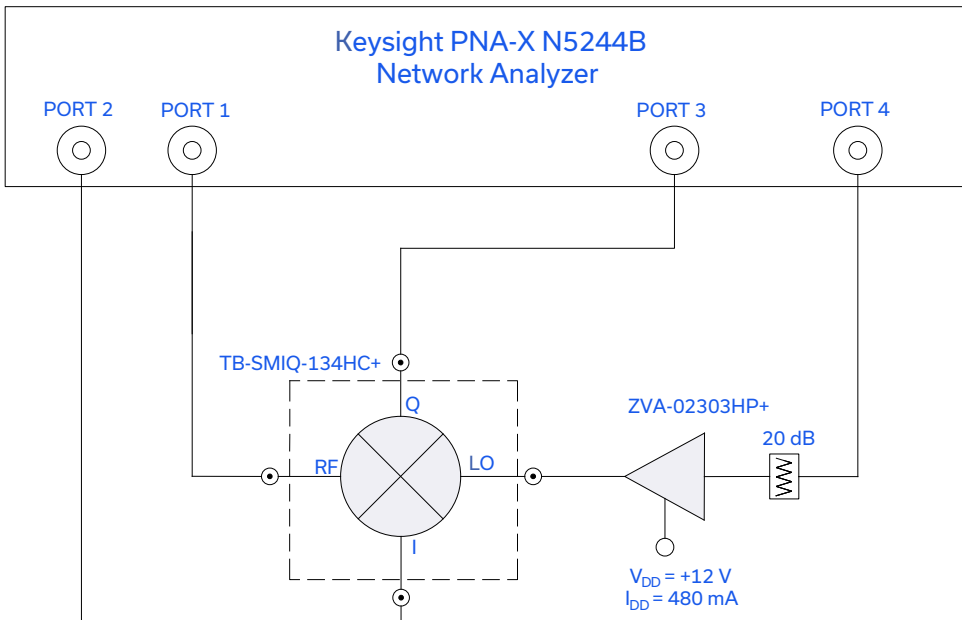

Figure 2. Block diagram of test circuit used to characterize: Conversion Loss, Amplitude Unbalance, Phase Unbalance, Isolation, and Return Loss

Test conditions:

RF Input Power = -10 dBm, LO Input Power = +17 to +19 dBm, IF = 200 MHz, 1 GHz, 2 GHz, 3 GHz, 4 GHz, 5 GHz, 6 GHz, and 7 GHz



20 dB attenuator P/N BW-KM20-2W44+

Figure 3. Block diagram of Test Circuit used for characterization of Image Rejection (Downconverter)

Test conditions:

RF Input Power = -10 dBm, LO Input Power = +17 to +19 dBm, IF = 200 MHz, 1 GHz, 2 GHz, 3 GHz, 4 GHz, and 5 GHz

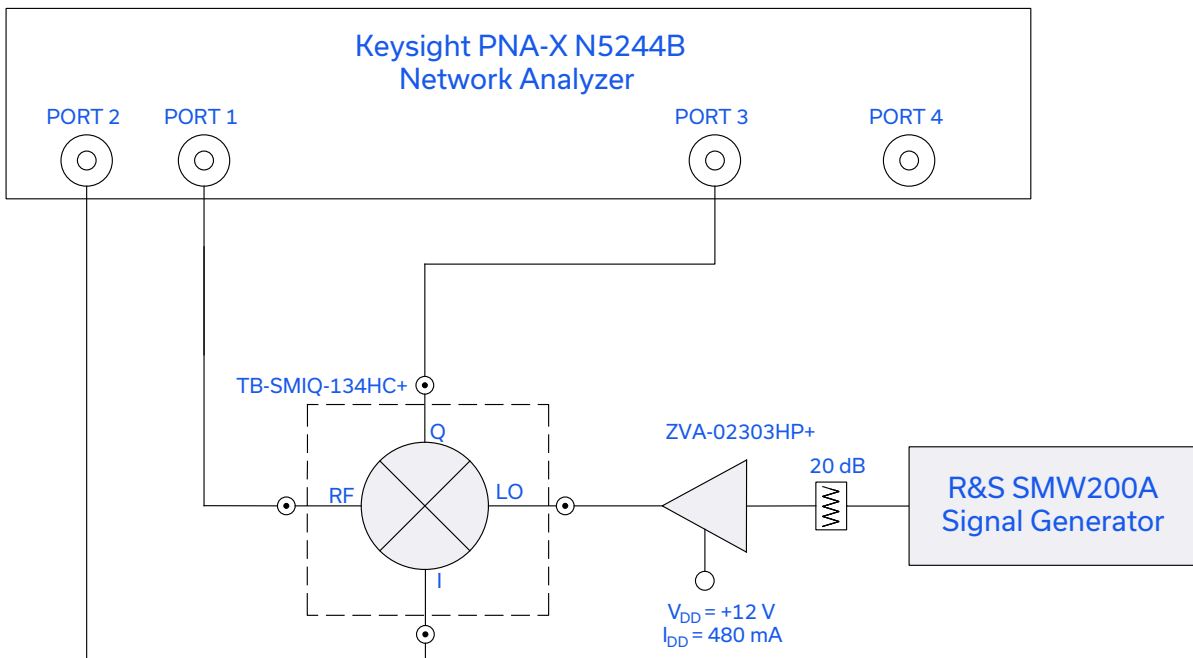

20 dB attenuator P/N BW-KM20-2W44+

Figure 4. Block diagram of Test Circuit used for characterization of Single Sideband Rejection (Upconverter) and Input IP3

Test conditions (For Single Sideband Rejection):

IF Input Power = -10 dBm, LO Input Power = +17 to +19 dBm, IF = 200 MHz, 1 GHz, 2 GHz, 3 GHz, 4 GHz, and 5 GHz

Test Conditions (For Input IP3):

RF Input Power = -10 dBm/Tone, LO Input Power = +17 to +19 dBm. Two tones, spaced 30 MHz apart.

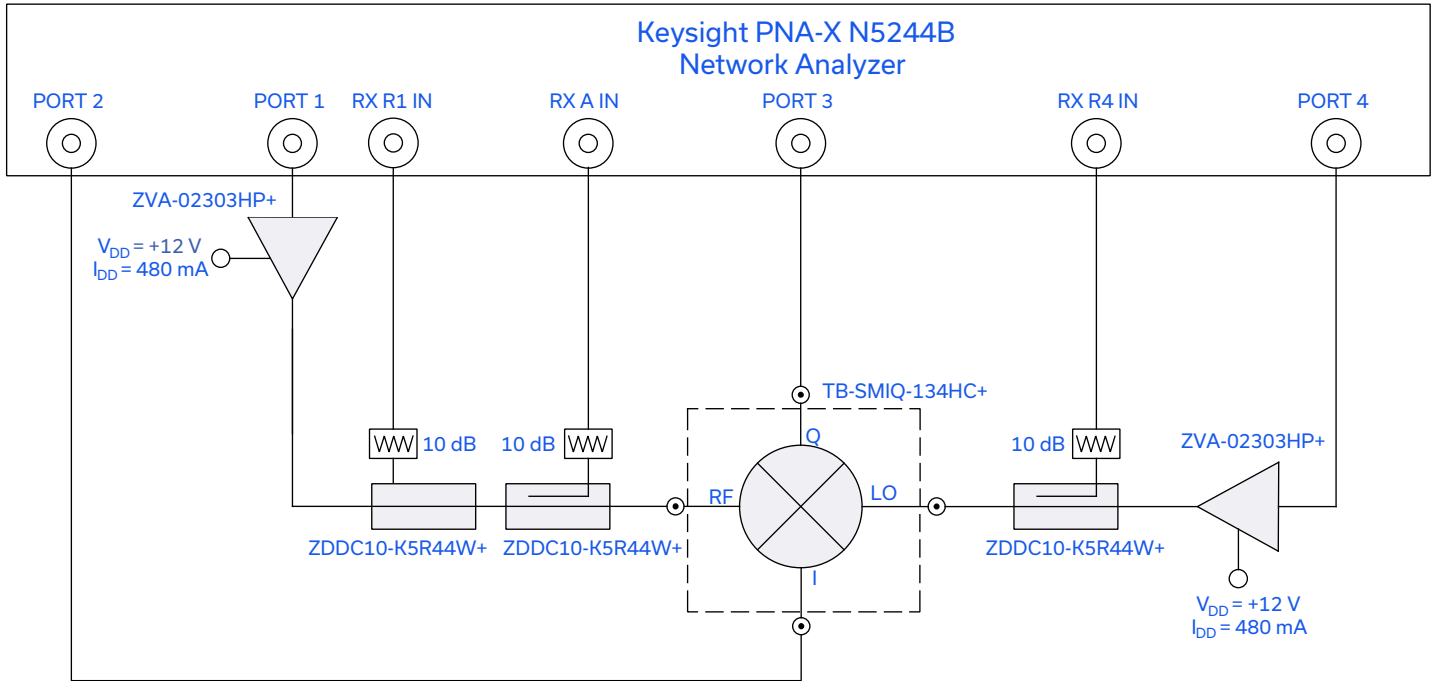

Figure 5. Block diagram of Test Circuit used for characterization of Compression

For Compression:

RF Input Power = -17 dBm and +17 dBm, LO Input Power = +17 to +19 dBm, IF = 200 MHz, 1 GHz, 2 GHz, 3 GHz, 4 GHz, 5 GHz, 6 GHz, and 7 GHz
Compression = (Conversion Loss @ RF Power = +17 dBm) - (Conversion Loss @ RF Power = -17 dBm)



APPLICATION CONFIGURATION FOR IMAGE REJECT AND SINGLE SIDE BAND MIXER

In Image Reject or Single Sideband Upconverter applications an external 90° Hybrid is needed. Refer to Mini-Circuits extensive portfolio of 90° Hybrids.

IMAGE REJECT MIXER APPLICATION

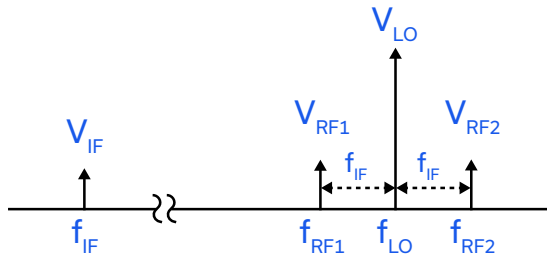

Figure 6. Spectral representation of Signals

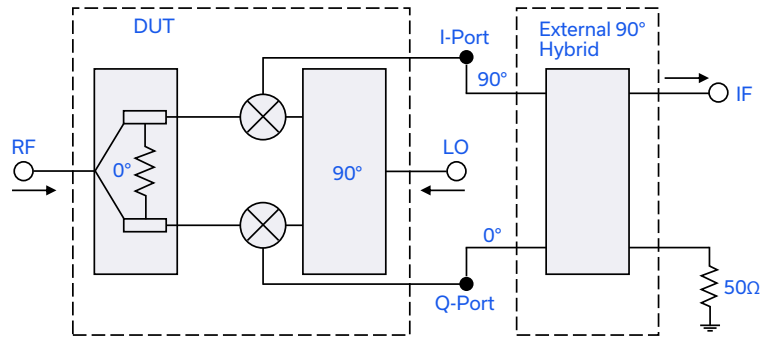

Figure 7. Block Diagram of Image Reject Mixer

If f_{RF1} is the desired signal and f_{RF2} is the image, connect the I port of DUT to the 90° port of the external hybrid and the Q port to the 0° port of the hybrid. This will send the $f_{RF2} - f_{LO}$ IF signal to the terminated output of the external 90° hybrid and desired IF signal $f_{LO} - f_{RF1}$ to IF port.

If f_{RF2} is the desired signal and f_{RF1} is the image signal, connect the I port of DUT to the 0 deg port of the external 90° hybrid and the Q port to the 90° port of the external hybrid. This will send $f_{LO} - f_{RF1}$ IF signal to the terminated output of the external 90° hybrid and desired IF signal $f_{RF2} - f_{LO}$ to IF port.

SINGLE SIDE BAND (SSB) UPCONVERTER APPLICATION

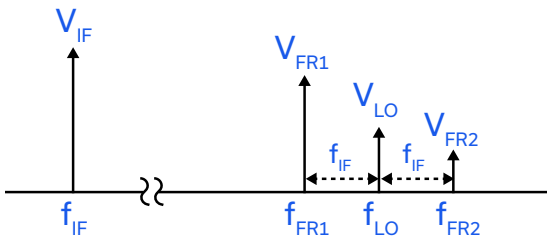

Figure 8. Spectral representation of Signals

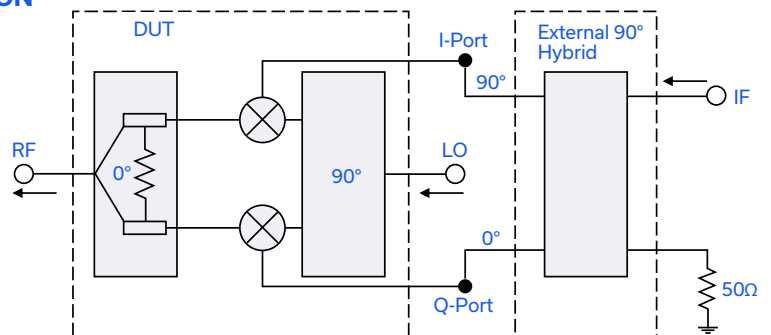

Figure 9. Block Diagram of Single Side Band Mixer

For upper sideband selection connect the I port to the 90° port of the external 90° hybrid and the Q port to the 0° port of the external hybrid. This will cause cancellation of the lower sideband signal in the 0° RF splitter of the DUT and the upper sideband signal will be present at the RF port.

For lower sideband selection connect the I port to the 0° port of the external 90° hybrid and the Q port to the 90° port of the hybrid. This will cause cancellation of the upper sideband signal in the 0° RF splitter of the DUT and the lower sideband signal will be present at the RF port.

Refer to Mini-Circuits blog, I&Q Mixers, Image Reject Down-Conversion & Single Sideband (SSB) Up-Conversion for a detailed explanation.



CASE STYLE DRAWING

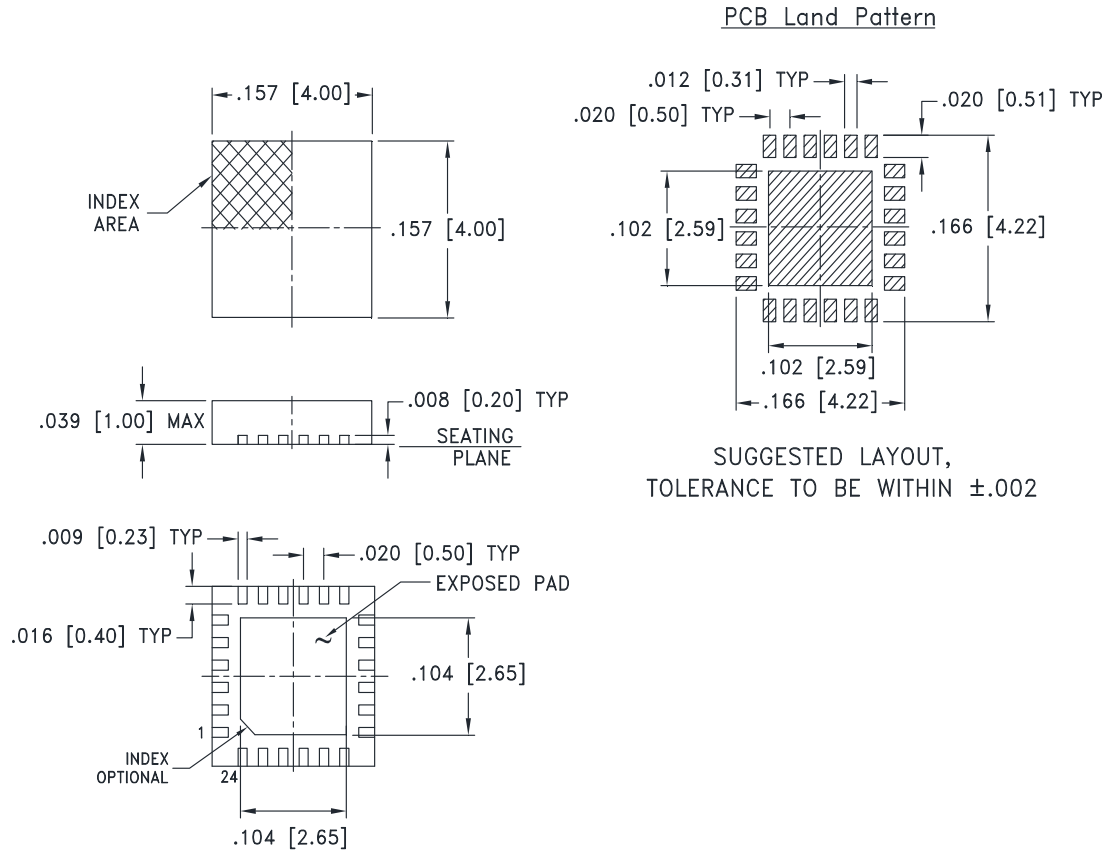

Weight: .04 Grams

Dimensions are in inches [mm]. Tolerances (values are in inches): 2 Pl. ± .01; 3 Pl. ± .005

PRODUCT MARKING

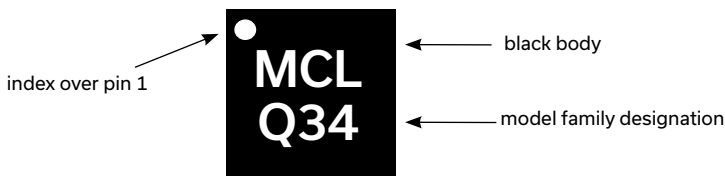

Marking may contain other features or characters for internal lot control



MMIC SURFACE MOUNT

IQ Mixer

SMIQ-134H+

50Ω Level 18 (LO Power +18 dBm) 10 to 30 GHz

ADDITIONAL DETAILED INFORMATION IS AVAILABLE ON OUR DASH BOARD

[CLICK HERE](#)

Performance Data and Graphs	Data Graphs Data Set (.zip file)
Case Style	DG1847 Plastic package, exposed paddle, lead finish: Matte-Tin
RoHS Status	Compliant
Tape & Reel Standard quantities available on reel	F68 7" reels with 20, 50, 100, 200, 500, or 1K devices
Suggested Layout for PCB Design	PL-787
Evaluation Board	TB-SMIQ-134HC+
Environmental Ratings	ENV08T1

Notes

- A. Performance and quality attributes and conditions not expressly stated in this specification document are intended to be excluded and do not form a part of this specification document.
- B. Electrical specifications and performance data contained in this specification document are based on Mini-Circuits' applicable established test performance criteria and measurement instructions.
- C. The parts covered by this specification document are subject to Mini-Circuits' standard limited warranty and terms and conditions (collectively, "Standard Terms"); Purchasers of this part are entitled to the rights and benefits contained there in. For a full statement of the standard. Terms and the exclusive rights and remedies thereunder, please visit Mini-Circuits' website at www.minicircuits.com/MCLStore/terms.jsp
- D. Mini-Circuits does not warrant the accuracy or completeness of the information, text, graphics and other items contained within this document and same are provided as an accommodation and on an As is basis, with all faults.
- E. Purchasers of this part are solely responsible for proper storing, handling, assembly and processing of known good die (KGD) (including, without limitation, proper ESD preventative measures, die preparation, die attach, wire bonding and related assembly and test activities), and Mini-Circuits assumes no responsibility therefor or for environmental effects on KGD.
- F. Mini-Circuits and the Mini-Circuits logo are registered trademarks of Scientific Components Corporation d/b/a Mini-Circuits. All other third-party trademarks are the property of their respective owners. A reference to any third-party trademark does not constitute or imply any endorsement, affiliation, sponsorship, or recommendation by any such third-party of Mini-Circuits or its products.

