

PPI[®]

HIGH POWER COMPONENTS FOR HIGH CURRENT/ HIGH VOLTAGE APPLICATIONS

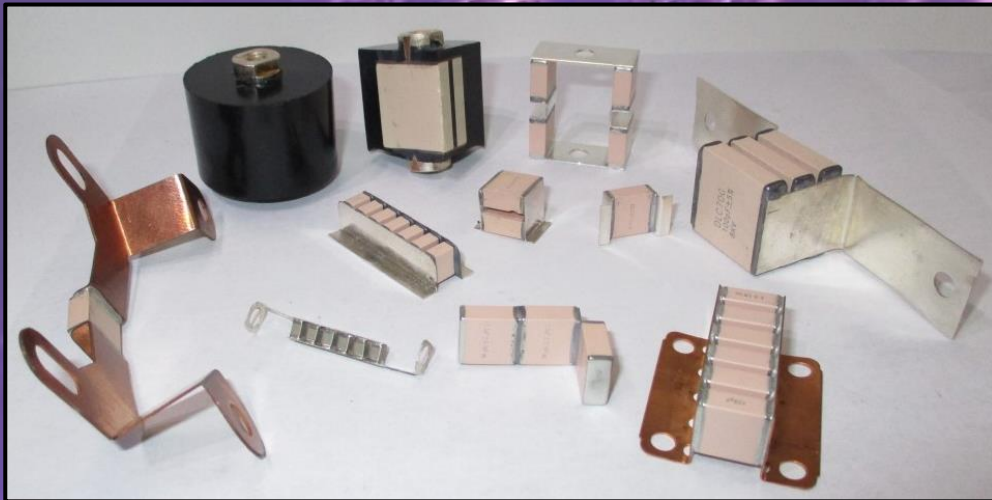

- High-Q Low ESR Capacitors
- High Power Custom Assemblies



Traditional High Q (>10,000) Low ESR Multi-Layer Ceramic Capacitors

Product Features

- High Q
- High Power
- Low ESR/ESL
- Low Noise
- High Self-Resonance
- Ultra Stable Performance

Product Applications

Typical Functional Applications:

- Tuning • Bypass • Coupling
- Feedback • D.C. Blocking
- Impedance Matching

Typical Circuit Applications:

- UHF/Microwave RF Power Amplifiers
- Mixers • Oscillators • Filter Networks
- Low Noise Amplifiers • Timing Circuits and Delay Lines

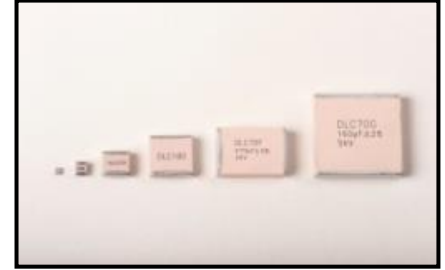

Marking shown for illustration purposes only.
Actual marking may differ.

Part Numbering

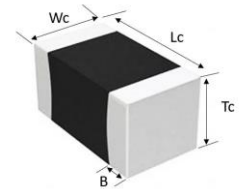
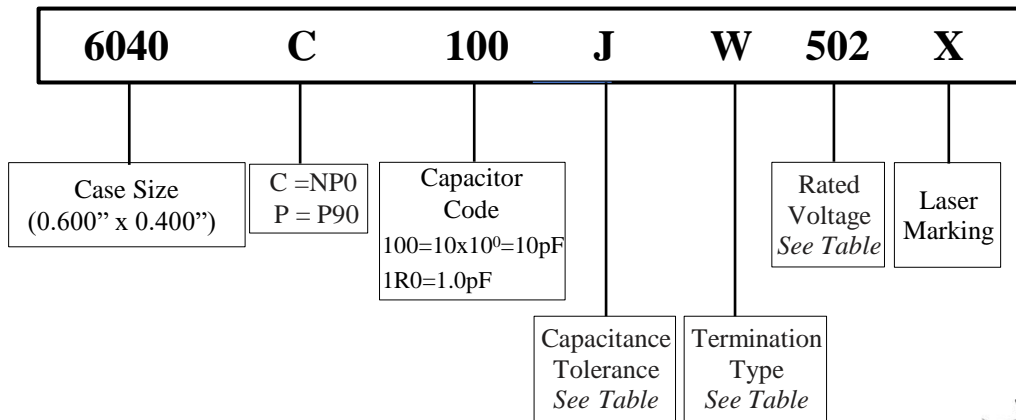

Case Size (Chip) Dimensions

	2225	3838	6040	7676
Length (L_c)	0.225 -0.010+0.25 (5.72 -0.25+ 0.64)	0.380 -0.010+0.015 (9.65 -0.25+0.38)	0.614 -0.010+0.015 (15.6 -0.25+0.38)	0.760 -0.010+0.015 (19.3 -0.25+0.38)
Width (W_c)	0.250 ± 0.015 (6.35 ± 0.38)	0.380±0.010 (9.65±0.25)	0.433±0.010 (11.0±0.25)	0.760±0.010 (19.3±0.25)
Thickness (T_c)	0.150 (3.81) max	0.170 (4.32) max	0.154±0.008 (3.90±0.20) max	0.154±0.008 (3.90±0.20) max
Overlap (B)	0.020~0.470 (0.50~1.20) max	0.024~0.059 (0.60~1.50)	0.063 (1.60) max	0.063 (1.60) max



Traditional High Q (>10,000) Low ESR Multi-Layer Ceramic Capacitors

≠ Temperature Coefficient

C: -55°C to 125°C 0±30ppm/°C; >125 °C to 200°C 0±60ppm/°C
 P: +90±20ppm/°C

≠ Rated Capacitance

Capacitance is less than 10pF; for example: 1R0=1.0pF, R denotes decimal point
 Capacitance greater than 10pF; for example: 101=100pF, the third number is the power of 10

≠ Tolerance

Capacitance Tolerance								
Code	A	B	C	D	F	G	J	K
Tolerance	±0.05pF	±0.1pF	±0.25pF	±0.5pF	±1%	±2%	±5%	±10%

≠ Termination Types and Codes

Magnetic			⊗ Non-Magnetic ⊗		
Termination Code	Type	Magnetic Termination	Termination Code	Type	Non-Magnetic Terminations
W	Chip	100% Sn Solder over Nickel Plating	P	Chip	100% Sn Solder over Copper Plating
L	Chip	90% Sn10%Pb Tin/Lead Solder over Nickel Plating	MN	Microstrip	Silver-Plated Copper
MS	Microstrip	Silver-Plated Copper	AN	Axial Ribbon	
AR	Axial Ribbon		FN	Radial Ribbon	
RR	Radial Ribbon		RN	Axial Wire	
RW	Axial Wire		BN	Radial Wire	
AW	Radial Wire				



Traditional High Q (>10,000) Low ESR Multi-Layer Ceramic Capacitors

≠ Voltages

Code	Rated Voltage	Code	Rated Voltage
501	500V	362	3600V
102	1000V	502	5000V
152	1500V	722	7200V
202	2000V	802	8000V
252	2500V	103	10000V
302	3000V		

≠ Laser Marking

An “X” at the end of the part number indicates the part is marked.

≠ Performance Requirements

Capacitors are designed and manufactured to meet the requirements of MIL-PRF-55681 and MIL-PRF-123.

All products are in compliance with RoHS instruction. 





Traditional High Q (>10,000) Low ESR
Multi-Layer Ceramic Capacitors

2225C/P (0.220" x 0.250")

≠ Product Features

- High Q
- High RF Current/Voltage
- Ultra Stable Performance
- Capacitance Range:
0.5pF to 2700pF
- Working Voltage: 2500V
- Extended Voltage: 3600V

≠ Product Applications

Typical Functional Applications:

- Tuning • Bypass • Coupling
- Feedback • D.C. Blocking
- Impedance Matching

Typical Circuit Applications:

- UHF/Microwave RF Power Amplifiers
- Antenna Tuning • Plasma Chambers
- Medical Equipment

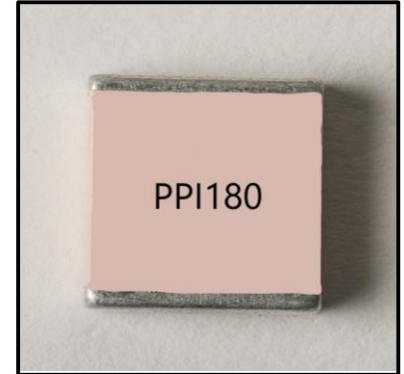

Marking shown for illustration purposes only.
Actual marking may differ.

≠ Part Numbering

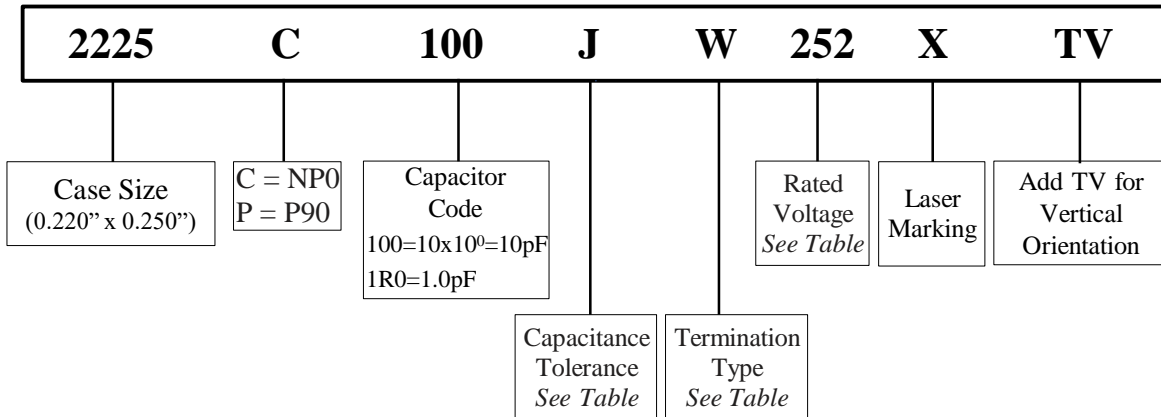

≠ Capacitance Tolerance Codes

Code	A	B	C	D	F	G	J	K
Tol.	±0.05pF	±0.1pF	±0.25pF	±0.5pF	±1%	±2%	±5%	±10%

≠ Voltage Codes

Voltage	Code	Voltage	Code
500V	501	2500V	252
1000V	102	3000V	302
1500V	152	3600V	362
2000V	202		



Traditional High Q (>10,000) Low ESR
Multi-Layer Ceramic Capacitors

2225C/P (0.220" x 0.250")

≠ 2225C/P Capacitance Values

- NP0=C; P90=P

Special capacitances, tolerances and WVDC are available. Please contact PPI.

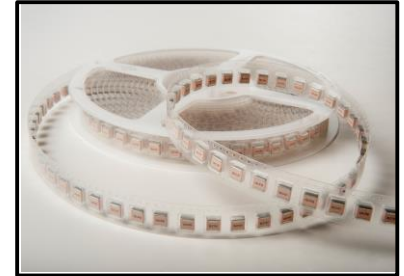

Cap. pF	Cap Code	Tol.	Rated WVDC		Cap. pF	Cap Code	Tol.	Rated WVDC		Cap. pF	Cap Code	Tol.	Rated WVDC		Cap. pF	Cap Code	Tol.	Rated WVDC	
			Std.	Ext.				Std.	Ext.				Std.	Ext.				Std.	Ext.
0.5	0R5				4.3	4R3				43	430				430	431	F,G, J,K	1500V	2000V
0.6	0R6				4.7	4R7				47	470				470	471			
0.7	0R7				5.1	5R1				51	510				510	511			
0.8	0R8				5.6	5R6				56	560				560	561			
0.9	0R9				6.2	6R2	B,C, D	2500V	3600V	62	620	F,G, J,K	2500V	3600V	620	621			
1.0	1R0				6.8	6R8				68	680				680	681			
1.1	1R1				7.5	7R5				75	750				750	751	F,G, J,K	1000V	1500V
1.2	1R2				8.2	8R2				82	820				820	821			
1.3	1R3				9.1	9R1				91	910				910	911			
1.4	1R4				10	100				100	101				1000	102			
1.5	1R5				11	110				110	111				1100	112			
1.6	1R6	B,C, D	2500V	3600V	12	120				120	121				1200	122			
1.7	1R7				13	130				130	131				1500	152			
1.8	1R8				15	150				150	151				1800	182	F,G, J,K	500V	N/A
1.9	1R9				16	160				160	161	F,G, J,K	2500V	3000V	2200	222			
2.0	2R0				18	180				180	181				2700	272			
2.1	2R1				20	200	F,G, J,K	2500V	3600V	200	201								
2.2	2R2				22	220				220	221								
2.4	2R4				24	240				240	241								
2.7	2R7				27	270				270	271								
3.0	3R0				30	300				300	301								
3.3	3R3				33	330				330	331	F,G, J,K	1500V	2000V					
3.6	3R6				36	360				360	361								
3.9	3R9				39	390				390	391								

≠ Termination Types and Codes

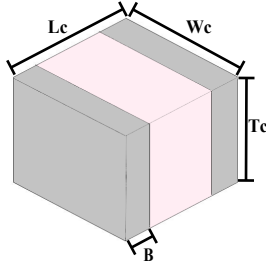

Chip Termination:
Codes: W, L, P

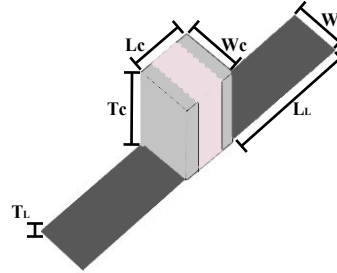

Microstrip Termination:
Codes: MS, MN

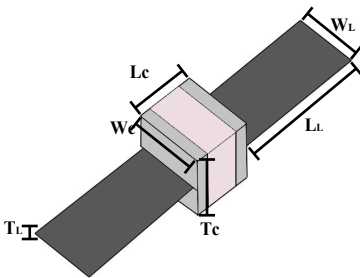

Axial Ribbon Termination:
Code: AR, AN

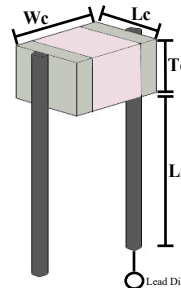

Radial Wire Termination:
Codes: RW, RN

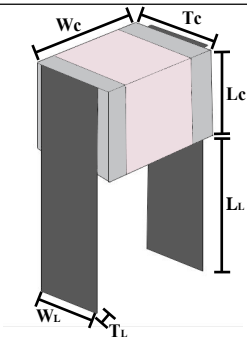

Radial Ribbon Termination:
Code: RR, FN

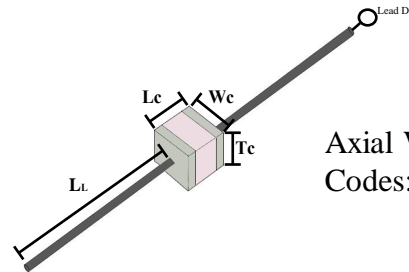

Axial Wire Termination:
Codes: AW, BN

Termination Code	Magnetic Termination
W	100% Tin Solder over Nickel Barrier
L	90%Tin/10%Lead Solder over Nickel Barrier
MS	Silver-Plated Copper
AR	
RR	
RW	
AW	

Termination Code	Non-Magnetic Termination
P	100% Tin Solder over Copper Barrier
MN	Silver-Plated Copper
AN	
FN	
RN	
BN	

Note: "Non-Magnetic" means no magnetic materials.



Traditional High Q (>10,000) Low ESR
Multi-Layer Ceramic Capacitors

2225C/P (0.220" x 0.250")

≠ **Dimensions** - For Termination Types images, see previous page Unit: inch (millimeter)

Magnetic Termination								
Code		Capacitor Dimensions				Lead Dimensions		
		Length	Width	Thickness	Overlap	Length	Width	Thickness
		Lc	Wc	Tc	B	LL	WL	TL
W/L	Chip	0.225 ^{+0.025} -0.010 (5.72 ^{+0.64} -0.25)	0.250 ± 0.015 (6.35 ± 0.38)	0.165 max (4.19 max)	0.020 ~ 0.047 (0.50 ~ 1.20)	-	-	-
MS	Microstrip					0.500 min (12.70 min)	0.240 ± 0.005 (6.1 ± 0.13)	0.008 ± 0.001 (0.2 ± 0.025)
AR	Axial Ribbon							
RR	Radial Ribbon	0.245 ± 0.025 (6.22 ± 0.64)	0.250 ± 0.015 (6.35 ± 0.38)	0.150 max (3.81 max)	-	0.354 min (9.00 min)	0.118 ± 0.005 (3.00 ± 0.13)	0.012 ± 0.001 (0.3 ± 0.025)
RW	Radio Wire					0.709 min (18.00 min)	Dia. = 0.031 ± 0.004	
AW	Axial Wire					0.906 min (23.00 min)	Dia. = (0.80 ± 0.10)	

Non-Magnetic Termination								
Code		Capacitor Dimensions				Lead Dimensions		
		Length	Width	Thickness	Overlap	Length	Width	Thickness
		Lc	Wc	Tc	B	LL	WL	TL
P	Chip	0.225 ^{+0.025} -0.010 (5.72 ^{+0.64} -0.25)	0.250 ± 0.015 (6.35 ± 0.38)	0.165 max (4.19 max)	0.020 ~ 0.047 (0.50 ~ 1.20)	-	-	-
MN	Microstrip					0.500 min (12.70 min)	0.240 ± 0.005 (6.1 ± 0.13)	0.008 ± 0.001 (0.2 ± 0.025)
AN	Axial Ribbon							
FN	Radial Ribbon	0.245 ± 0.025 (6.22 ± 0.64)	0.250 ± 0.015 (6.35 ± 0.38)	0.150 max (3.81 max)	-	0.354 min (9.00 min)	0.118 ± 0.005 (3.00 ± 0.13)	0.012 ± 0.001 (0.3 ± 0.025)
RN	Radio Wire					0.709 min (18.00 min)	Dia. = 0.031 ± 0.004	
BN	Axial Wire					0.906 min (23.00 min)	Dia. = (0.80 ± 0.10)	

⊗ Note: Non-Magnetic means no magnetic materials. All leads are attached with high temperature solder and parts are RoHS Compliant.



Traditional High Q (>10,000) Low ESR
Multi-Layer Ceramic Capacitors

2225C/P (0.220" x 0.250")

⚡ Electrical Specifications

Quality Factor (Q)	Greater than 10,000 at 1 MHz
Insulation Resistance (IR)	Test Voltage: 500V 10 ⁵ Megaohms min. @ +25°C 10 ⁴ Megaohms min. @ +125°C
Rated Voltage	See Rated Voltage in Capacitance Table
Dielectric Withstanding Voltage (DWV)	250% of Rated Voltage of 5 seconds, Rated Voltage ≤ 500VDC 150% of Voltage for 5 seconds, 500VDC < Rated Voltage ≤ 1250 VDC 120% of Voltage for 5 seconds, Rated Voltage > 1250 VDC
Operating Temperature Range	-55°C to 200°C
Temperature Coefficient (TC)	C: -55°C to 125°C 0±30ppm/°C; >125°C to 200°C 0±60ppm/°C P: -55°C to 200°C +90±20ppm/°C
Capacitance Drift	±0.02% or ±0.02pF, whichever is greater
Piezoelectric Effects	None
Termination Type	See Termination Type Table

Capacitors are designed and manufactured to meet the requirements of MIL-PRF-55681 and MIL-PRF-123.

⚡ Environmental Specifications

	Specification	Test Parameters
Thermal Shock	DWV: The initial Value IR: Shall not be less than 30% of the initial value. Capacitance Change:	MIL-STD-202, Method 107, Condition A. At the maximum rated temperature (-55°C and 200°C) stay 30 minutes, the time of removing shall not be more than 3 minutes. Perform five cycles.
Moisture Resistance	No more than 0.5% or 0.5pF, whichever is greater.	MIL-STD-202, Method 106
Humidity (Steady State)	DWV: The initial Value IR: The initial value. Capacitance Change: No more than 0.3% or 0.3pF, whichever is greater.	MIL-STD-202, Method 103, Condition A With 1.5Volts DC applied while subjected to an environment of 85°C with 85% relative humidity for 240 hours minimum.
Life	IR: Shall not be less than 30% of the initial value. Capacitance Change: No more than 2.0% or 0.5pF, whichever is greater.	MIL-STD-202, Method 108. For 2000 hours, at 200°C. 200% of Voltage for Capacitors, Rated Voltage ≤ 500VDC; 120% of Voltage for Capacitors, 500VDC < Rated Voltage ≤ 1250VDC; 100% for Voltage for Capacitors, Rated Voltage > 1250VDC
Terminal Strength	Force: 20lbs typical, 10lbs. Minimum. Duration Time: 5 to 10 seconds	MIL-STD-202, Method 211A, Test Condition A. Applied a force and maintained for a period of 5 to 10 seconds. The force shall be in the direction of the axes of the terminations.



Traditional High Q (>10,000) Low ESR
Multi-Layer Ceramic Capacitors

2225C/P (0.220" x 0.250")

≠ Series Resonance vs. Capacitance

Series Resonance vs. Capacitance

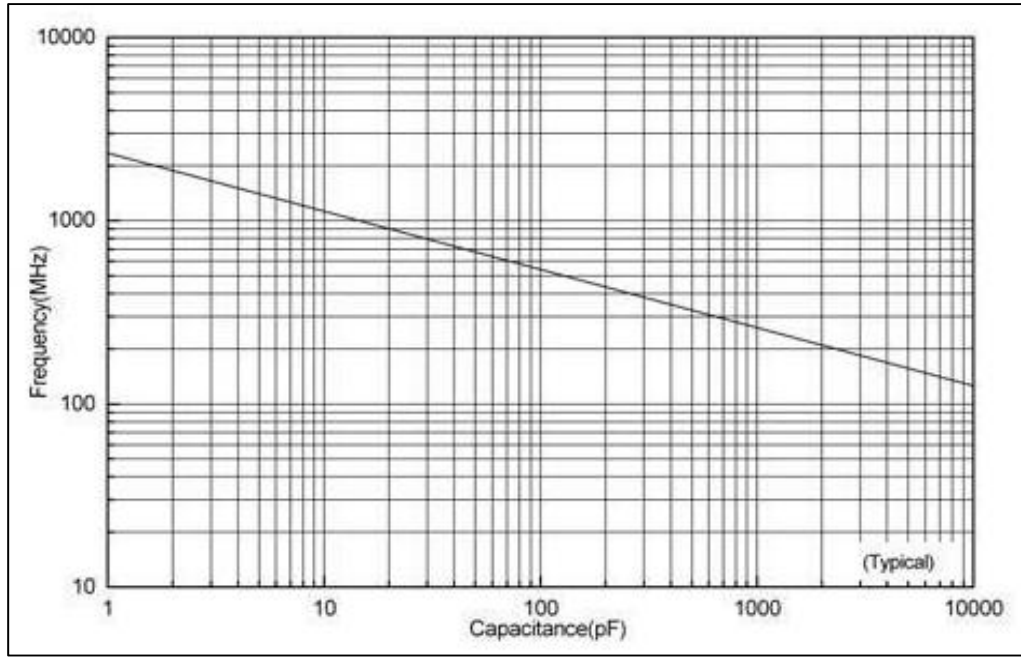

≠ ESR vs. Frequency

2225C/P ESR vs Frequency

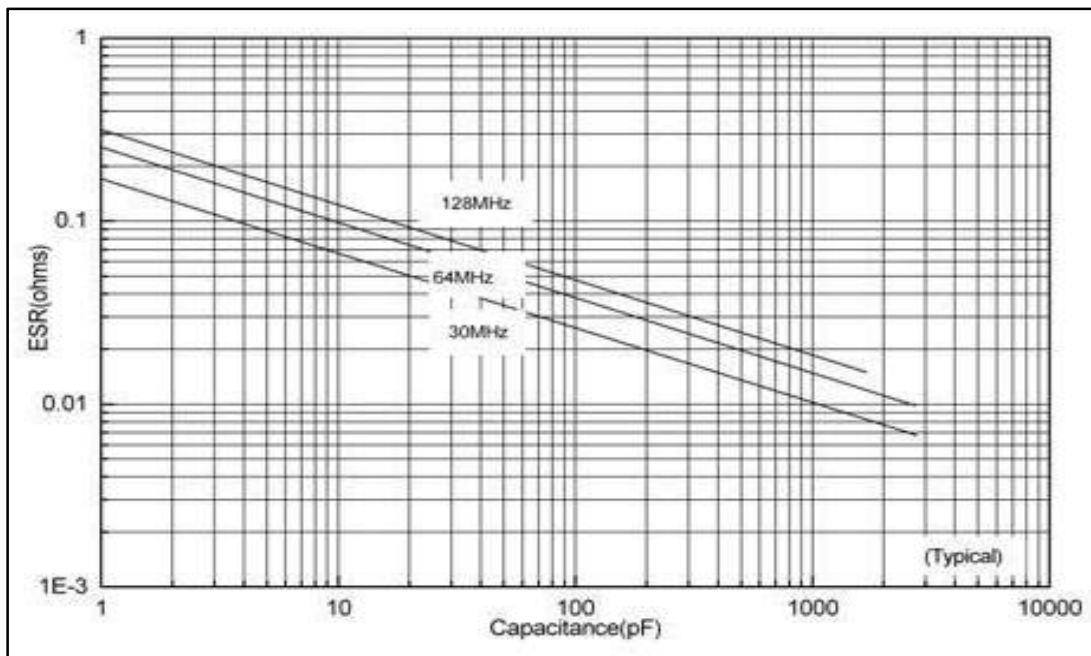



Traditional High Q (>10,000) Low ESR
Multi-Layer Ceramic Capacitors

2225C/P (0.220" x 0.250")

≠ Q vs. Capacitance

Q vs Capacitance

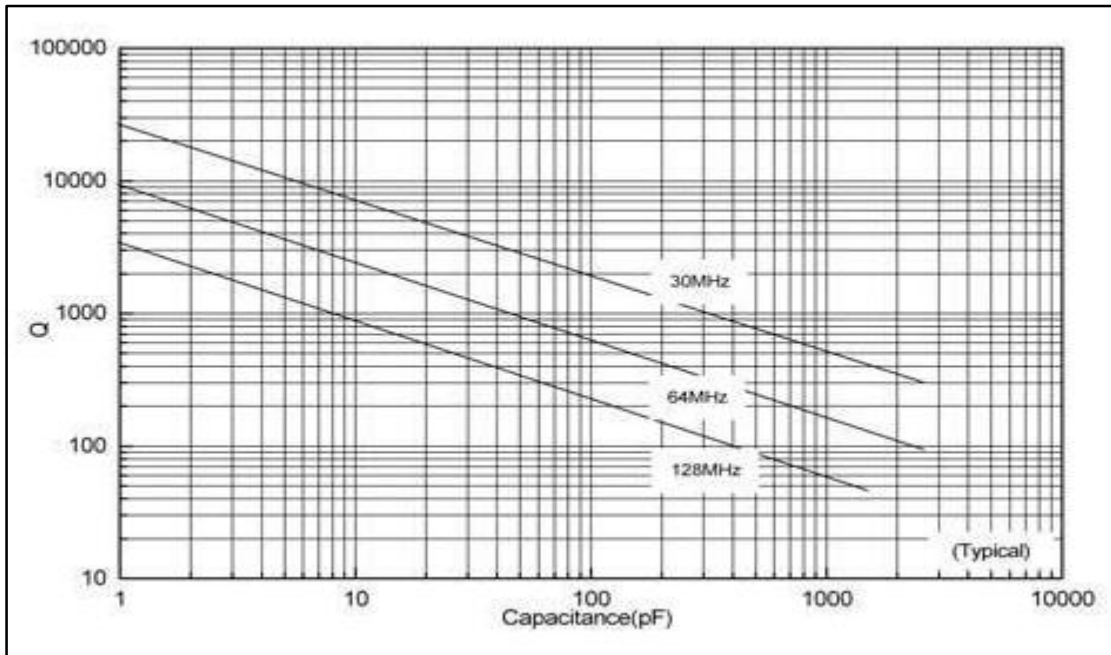

≠ Current Rating vs. Capacitance

2225C/P Current Rating vs Capacitance

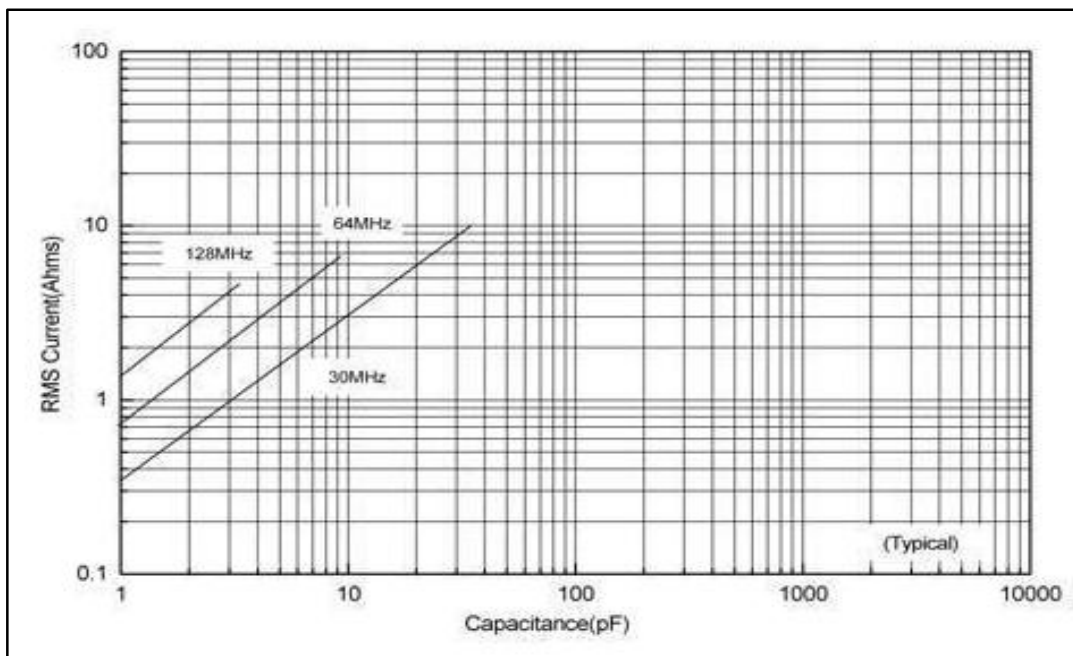

≠ Current Rating vs. Capacitance

2225C/P Current Rating vs Capacitance

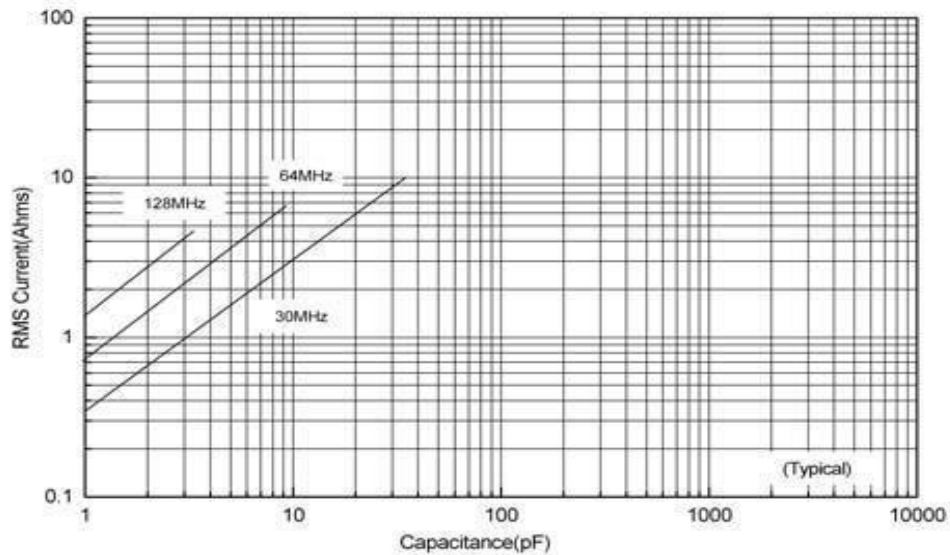

Current limits can depend on two different criteria. The first Voltage Limited Current ($I_{\text{voltage lim}}$, represented by the solid line), the second is Power Dissipation Limited Current ($I_{\text{power diss}}$).

$$I_{\text{voltage lim}} = \frac{\sqrt{2}}{2} I_{\text{peak}} = \frac{\sqrt{2}}{2} \times \frac{V_{\text{rated}}}{X_C} = \sqrt{2} \pi F C V_{\text{rated}}$$

$I_{\text{power diss}} = \sqrt{\frac{P_{\text{dissipation}}}{\text{ESR}}}$ (If the thermal resistance of the mounting surface is 15°C/W, then you will reach the power dissipated limit of 4W)



Traditional High Q (>10,000) Low ESR
Multi-Layer Ceramic Capacitors

2225C/P (0.220" x 0.250")

≠ Capacitor Application Program

PPI's brand new online Capacitor Application Program (C.A.P.) helps Engineers and Designers select capacitors according to parameters such as cap value and frequency. C.A.P. allows engineers to insert capacitors requirements (Cap value, Frequency), producing Scattering Matrices (S2P) Charts while providing options (Case Size, Terminations, Mounting), and parameters (ESR, Q, Impedance) along with Datasheets. Once engineers have determined their capacitor requirements, C.A.P. also includes online Requests For Quotes (RFQs) and/or sample requests.

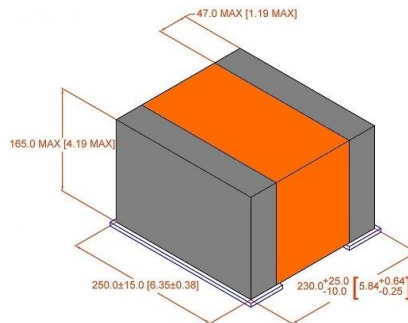

≠ Recommended Land Pattern Dimensions

Regarding Landing Patterns, please refer to IPC-7351B (table 3-5, 3-6).

≠ Custom Assemblies

Passive Plus offers Capacitor Assemblies for high power requirements. Typical assemblies are configured in series and/or parallel combinations, producing higher voltage/current handling capabilities, extended capacitance range and tighter tolerances.

To get started, simply send us either a mechanical drawing or circuit conditions and we can recommend a solution. All components are 100% up-screened for Partial Discharge and Sonoscanned. All assemblies include a 100hr Military burn in.

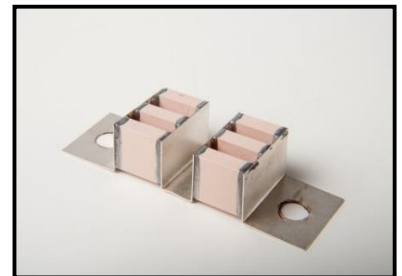



Traditional High Q (>10,000) Low ESR
Multi-Layer Ceramic Capacitors

2225C/P (0.220" x 0.250")

≠ Tape & Reel Specifications (mm)

Orientation	Measurement Unit	W	P0	P1	T	F	Minimum Qty per Reel	Std Qty per Reel	Tape Material
H	in.	0.630	0.157	0.472	0.012	0.295	500	500	Plastic
	mm	16.00	4.00	12.00	0.30	7.50			
V	in.	0.630	0.157	0.315	0.020	0.295	500	500	Plastic
	mm	16.00	4.00	8.00	0.50	7.50			

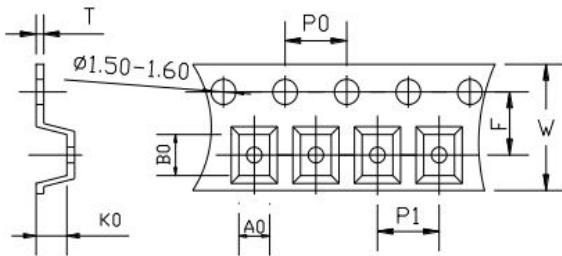

A₀B₀K₀

- Determined by component size. Typical clearance between the cavity and the component is: .50 (.002) min to .65 (.026) max for 12mm tape.
- The component cannot rotate more than 20° within the determined cavity.



Traditional High Q (>10,000) Low ESR
Multi-Layer Ceramic Capacitors

3838C/P (0.380" x 0.380")

≠ Product Features

- High Q
- High RF Current/Voltage
- Ultra Stable Performance
- Capacitance Range:
0.5pF to 5100pF
- Working Voltage: 3600V
- Extended Voltage: 7200V

≠ Product Applications

Typical Functional Applications:

- Tuning • Bypass • Coupling
- D.C. Blocking • Impedance Matching

Typical Circuit Applications:

- HF/RF Power Amplifiers
- Antenna Tuning • Plasma Chambers
- Medical Equipment • Transmitters



Marking shown for illustration purposes only.
Actual marking may differ.

≠ Part Numbering

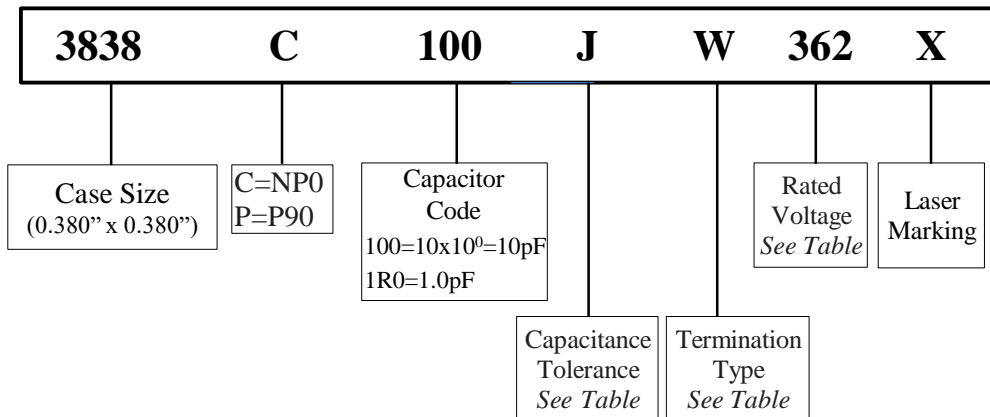

≠ Capacitance Tolerance Codes

Code	A	B	C	D	F	G	J	K
Tol.	±0.05pF	±0.1pF	±0.25pF	±0.5pF	±1%	±2%	±5%	±10%

≠ Voltage Codes

Voltage	Code
500V	501
1000V	102
2500V	252
3600V	362
7200V	722



Traditional High Q (>10,000) Low ESR
Multi-Layer Ceramic Capacitors

3838C/P (0.380" x 0.380")

≠ 3838C/P Capacitance Values

Special capacitances, tolerances and WVDC are available. Please contact PPI.

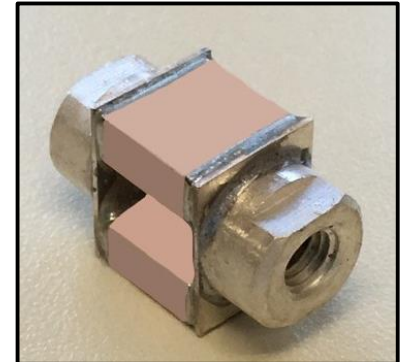

Cap. pF	Cap Code	Tol.	Rated WVDC		Cap. pF	Cap Code	Tol.	Rated WVDC		Cap. pF	Cap Code	Tol.	Rated WVDC		Cap. pF	Cap Code	Tol.	Rated WVDC
			Std.	Ext.				Std.	Ext.				Std.	Ext.				
0.5	OR5	B,C, D	3600V	7200V	4.7	4R7	B,C, D	3600V	7200V	51	510	F,G, J,K	3600V	7200V	560	561	F,G, J,K	2500V
0.6	OR6				5.1	5R1				56	560				620	621		
0.7	OR7				5.6	5R6				62	620				680	681		
0.8	OR8				6.2	6R2				68	680				750	751		
0.9	OR9				6.8	6R8				75	750				820	821		
1.0	1R0				7.5	7R5				82	820				910	911		
1.1	1R1				8.2	8R2				91	910				1000	102		
1.2	1R2				9.1	9R1				100	101				1100	112		
1.3	1R3				10	100				110	111				1200	122		
1.4	1R4				11	110	120	121	1500	152								
1.5	1R5				12	120	130	131	1800	182								
1.6	1R6				13	130	150	151	2200	222								
1.7	1R7				15	150	160	161	2400	242								
1.8	1R8				16	160	180	181	2700	272								
1.9	1R9				18	180	200	201	3000	302								
2.0	2R0				20	200	220	221	3300	332								
2.1	2R1				22	220	240	241	3600	362								
2.2	2R2				24	240	270	271	3900	392								
2.4	2R4				27	270	300	301	4300	432								
2.7	2R7	30	300	330	331	4700	472											
3.0	3R0	33	330	360	361	5100	512											
3.3	3R3	36	360	390	391													
3.6	3R6	39	390	430	431													
3.9	3R9	43	430	470	471	F,G, J,K	2500V	N/A										
4.3	4R3	47	470	510	511													

≠ Termination Types and Codes

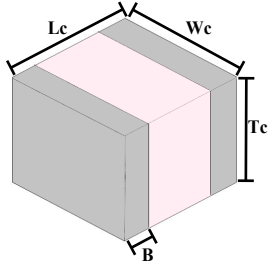

Chip Termination:
Codes: W, L, P

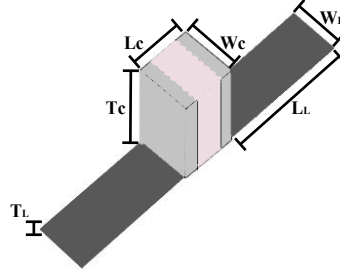

Microstrip Termination:
Codes: MS, MN

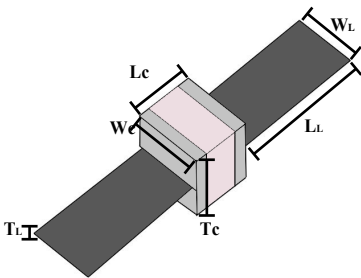

Axial Ribbon Termination:
Code: AR, AN

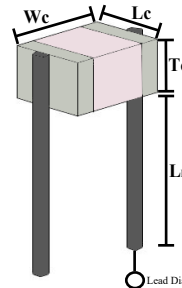

Radial Wire Termination:
Codes: RW, RN

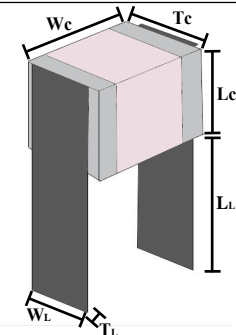

Radial Ribbon Termination:
Code: RR, FN

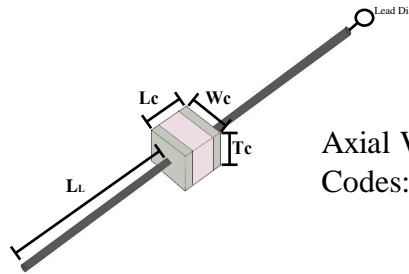

Axial Wire Termination:
Codes: AW, BN

Termination Code	Magnetic Termination
W	100% Tin Solder over Nickel Barrier
L	90%Tin/10%Lead Solder over Nickel Barrier
MS	Silver-Plated Copper
AR	
RR	
RW	
AW	

Termination Code	Non-Magnetic
P	100% Tin Solder over Copper Barrier
MN	Silver-Plated Copper
AN	
FN	
RN	
BN	

Note: "Non-Magnetic" means no magnetic materials.



Traditional High Q (>10,000) Low ESR
Multi-Layer Ceramic Capacitors

3838C/P (0.380" x 0.380")

≠ **Dimensions** - For Termination Types images, see previous page Unit: inch (millimeter)

Magnetic Termination								
Code		Capacitor Dimensions				Lead Dimensions		
		Length	Width	Thickness	Overlap	Length	Width	Thickness
		Lc	Wc	Tc	B	LL	WL	TL
W/L	Chip	0.380 (9.65	$\begin{matrix} +0.015 \\ -0.010 \\ +0.38 \\ -0.25 \end{matrix}$)	0.380 ± 0.010 (9.65 ± 0.25)	0.170 max (4.32 max)	0.024 ~ 0.059 (0.60 ~ 1.50)	-	-
MS	Microstrip					0.728 min (18.50 min)	0.350 ± 0.020 (8.89 ± 0.50)	0.008 ± 0.001 (0.20 ± 0.025)
AR	Axial Ribbon					0.728 min (18.50 min)	0.315 ± 0.010 (8.00 ± 0.25)	0.008 ± 0.001 (0.20 ± 0.025)
RR	Radial Ribbon	0.380 (9.65	$\begin{matrix} +0.015 \\ -0.010 \\ +0.38 \\ -0.25 \end{matrix}$)	0.380 ± 0.010 (9.65 ± 0.25)	0.177 max (4.50 max)	-	0.354 min (9.00 min)	0.118 ± 0.005 (3.00 ± 0.13)
RW	Radio Wire					0.709 min (18.00 min)		Dia. = 0.031 ± 0.004
AW	Axial Wire					0.906 min (23.00 min)		Dia. = (0.80 ± 0.10)

Non-Magnetic Termination								
Code		Capacitor Dimensions				Lead Dimensions		
		Length	Width	Thickness	Overlap	Length	Width	Thickness
		Lc	Wc	Tc	B	LL	WL	TL
P	Chip	0.380 (9.65	$\begin{matrix} +0.015 \\ -0.010 \\ +0.38 \\ -0.25 \end{matrix}$)	0.380 ± 0.010 (9.65 ± 0.25)	0.170 max (4.32 max)	0.024 ~ 0.059 (0.60 ~ 1.50)	-	-
MN	Microstrip					0.728 min (18.50 min)	0.350 ± 0.020 (8.89 ± 0.50)	0.008 ± 0.001 (0.20 ± 0.025)
AN	Axial Ribbon					0.728 min (18.50 min)	0.315 ± 0.010 (8.00 ± 0.25)	0.008 ± 0.001 (0.20 ± 0.025)
FN	Radial Ribbon	0.380 (9.65	$\begin{matrix} +0.015 \\ -0.010 \\ +0.38 \\ -0.25 \end{matrix}$)	0.380 ± 0.010 (9.65 ± 0.25)	0.177 max (4.50 max)	-	0.354 min (9.00 min)	0.118 ± 0.005 (3.00 ± 0.13)
RN	Radio Wire					0.709 min (18.00 min)		Dia. = 0.031 ± 0.004
BN	Axial Wire					0.906 min (23.00 min)		Dia. = (0.80 ± 0.10)

⊗ Note: Non-Magnetic means no magnetic materials. All leads are attached with high temperature solder and parts are RoHS Compliant.



Traditional High Q (>10,000) Low ESR
Multi-Layer Ceramic Capacitors

3838C/P (0.380" x 0.380")

⚡ Electrical Specifications

Quality Factor (Q)	Greater than 10,000 at 1 MHz
Insulation Resistance (IR)	Test Voltage: 500V 10 ⁵ Megaohms min. @ +25°C 10 ⁴ Megaohms min. @ +125°C
Rated Voltage	See Rated Voltage in Capacitance Table
Dielectric Withstanding Voltage (DWV)	250% of Rated Voltage of 5 seconds, Rated Voltage ≤ 500VDC 150% of Voltage for 5 seconds, 500VDC < Rated Voltage ≤ 1250 VDC 120% of Voltage for 5 seconds, Rated Voltage > 1250 VDC
Operating Temperature Range	-55°C to 200°C
Temperature Coefficient (TC)	C: -55°C to 125°C 0±30ppm/°C; >125°C to 200°C 0±60ppm/°C P: -55°C to 200°C +90±20ppm/°C
Capacitance Drift	±0.02% or ±0.02pF, whichever is greater
Piezoelectric Effects	None
Termination Type	See Termination Type Table

⚡ Environmental Specifications

	Specification	Test Parameters
Thermal Shock	DWV: The initial value IR: Shall not be less than 30% of the initial value. Capacitance Change:	MIL-STD-202, Method 107, Condition A. At the maximum rated temperature (-55°C and 200°C) stay 30 minutes, the time of removing shall not be more than 3 minutes. Perform five cycles.
Moisture Resistance	No more than 0.5% or 0.5pF, whichever is greater.	MIL-STD-202, Method 106
Humidity (Steady State)	DWV: The initial value IR: The initial value Capacitance Change: No more than 0.3% or 0.3pF, whichever is greater.	MIL-STD-202, Method 103, Condition A With 1.5Volts DC applied while subjected to an environment of 85°C with 85% relative humidity for 240 hours minimum.
Life	IR: Shall not be less than 30% of the initial value. Capacitance Change: No more than 2.0% or 0.5pF, whichever is greater.	MIL-STD-202, Method 108. For 2000 hours, at 200°C. 200% of Voltage for Capacitors, Rated Voltage ≤ 500VDC; 120% of Voltage for Capacitors, 500VDC < Rated Voltage ≤ 1250VDC; 100% for Voltage for Capacitors, Rated Voltage > 1250VDC
Terminal Strength	Force: 20lbs typical, 10lbs. min. Duration Time: 5 to 10 seconds	MIL-STD-202, Method 211A, Test Condition A. Applied a force and maintained for a period of 5 to 10 seconds. The force shall be in the direction of the axes of the terminations.

Capacitors are designed and manufactured to meet the requirements of MIL-PRF-55681 and MIL-PRF-123.



Traditional High Q (>10,000) Low ESR
Multi-Layer Ceramic Capacitors

3838C/P (0.380" x 0.380")

≠ Series Resonance vs. Capacitance

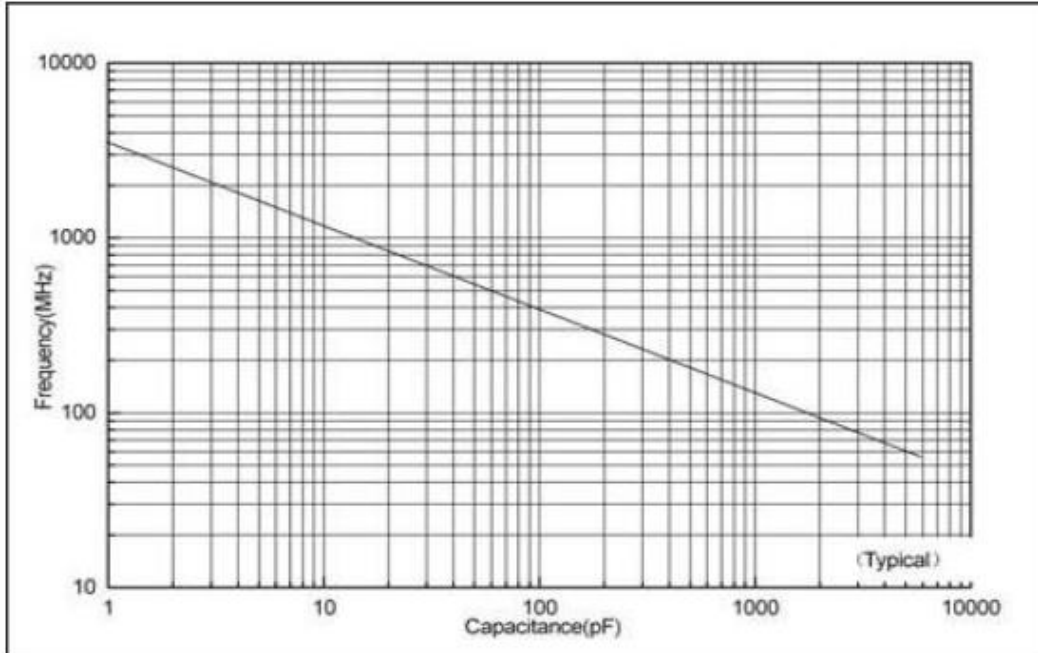

≠ ESR vs. Frequency

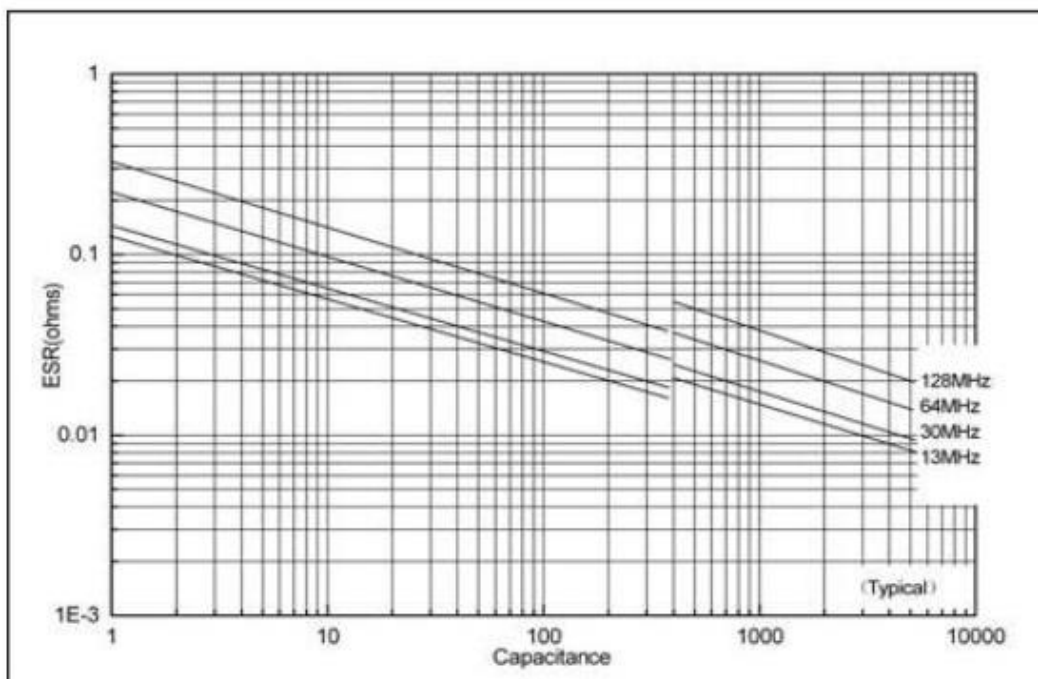



Traditional High Q (>10,000) Low ESR
Multi-Layer Ceramic Capacitors

3838C/P (0.380" x 0.380")

≠ Q vs. Capacitance

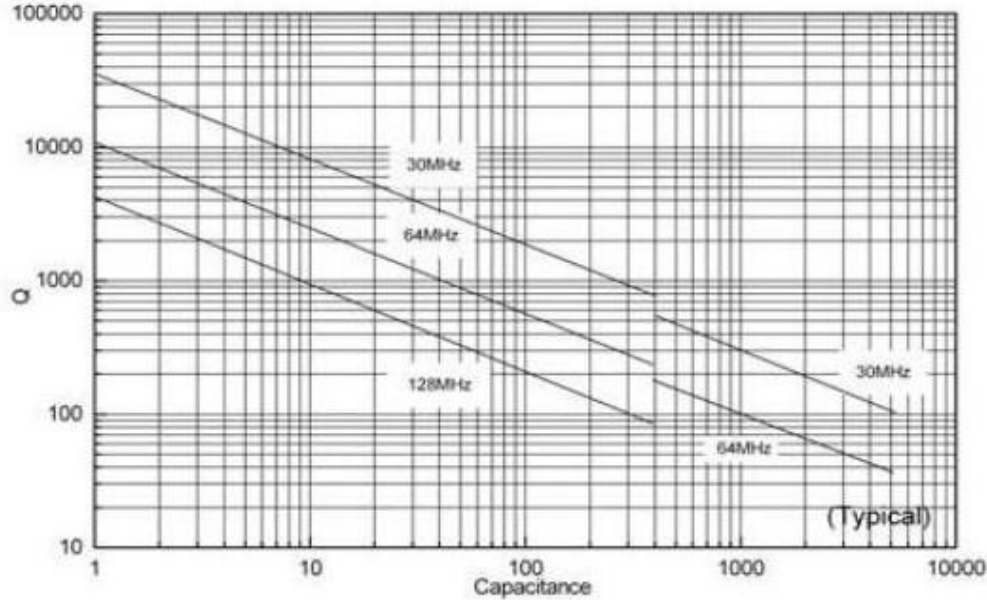

≠ Current Rating vs. Capacitance

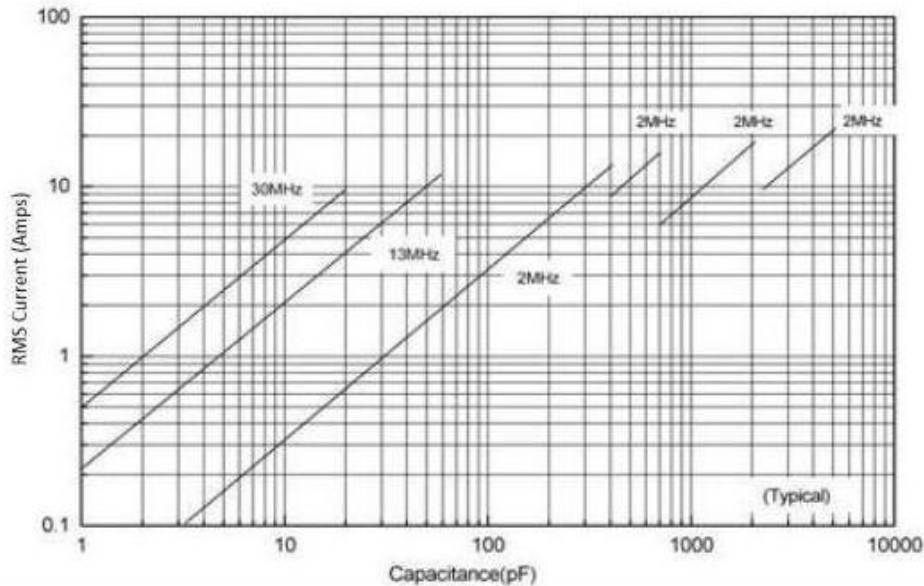

Current limits can depend on two different criteria. The first Voltage Limited Current ($I_{voltage\ lim}$, represented by the solid line), the second is Power Dissipation Limited Current ($I_{pow\ diss}$).

$$I_{voltage\ lim} = \frac{\sqrt{2}}{2} I_{peak} = \frac{\sqrt{2}}{2} \times \frac{V_{rated}}{X_C} = \sqrt{2}\pi F C V_{rated}$$

$I_{pow\ diss} = \sqrt{\frac{P_{dissipation}}{ESR}}$ (If the thermal resistance of the mounting surface is 12°C/W, then you will reach the power dissipated limit of 5W)



Traditional High Q (>10,000) Low ESR
Multi-Layer Ceramic Capacitors

3838C/P (0.380" x 0.380")

≠ Recommended Land Pattern Dimensions

Regarding Landing Patterns, please refer to IPC-7351B (table 3-5, 3-6).

≠ Custom Assemblies

Passive Plus offers Capacitor Assemblies for high power requirements. Typical assemblies are configured in series and/or parallel combinations, producing higher voltage/current handling capabilities, extended capacitance range and tighter tolerances.

To get started, simply send us either a mechanical drawing or circuit conditions and we can recommend a solution. All components are 100% up-screened for Partial Discharge and Sonoscanned. All assemblies include a 100hr Military burn in.

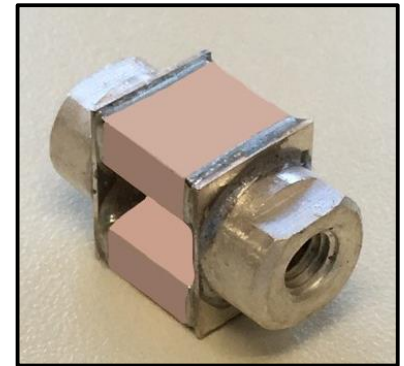

≠ Tape & Reel Specifications (mm)

Orientation	Measurement Unit	W	P0	P1	T	F	Minimum Qty per Reel	Std Qty per Reel	Tape Material
H	in.	0.630	0.157	0.630	0.012	0.295	50	200	Plastic
	mm	16.00	4.00	16.00	0.30	7.50			

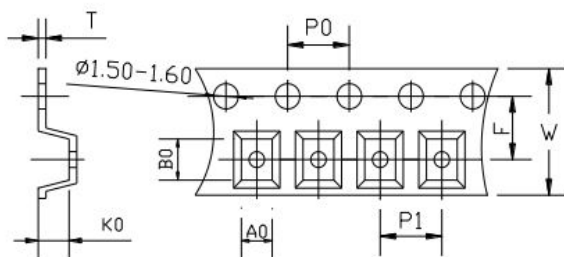

A₀B₀K₀

- Determined by component size. Typical clearance between the cavity and the component is: .50 (.002) min to .65 (.026) max for 12mm tape.
- The component cannot rotate more than 20° within the determined cavity.



≠ **Product Features**

- High Q
- High RF Current/Voltage
- Ultra Stable Performance
- Capacitance Range:
1.0pF to 6800pF
- Working Voltage: 5000V
- Extended Voltage: 8000V

≠ **Typical Circuit Applications**

- Semiconductor Manufacturing
- High Energy Power Transfers
- Plasma Chambers
- Medical Equipment

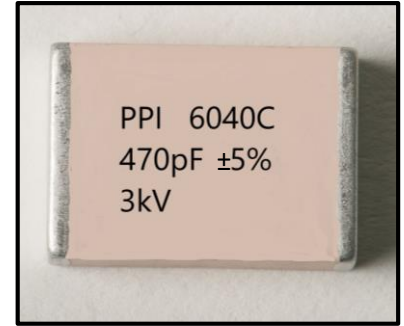

Marking shown for illustration purposes only.
Actual marking may differ.

≠ **Part Numbering**

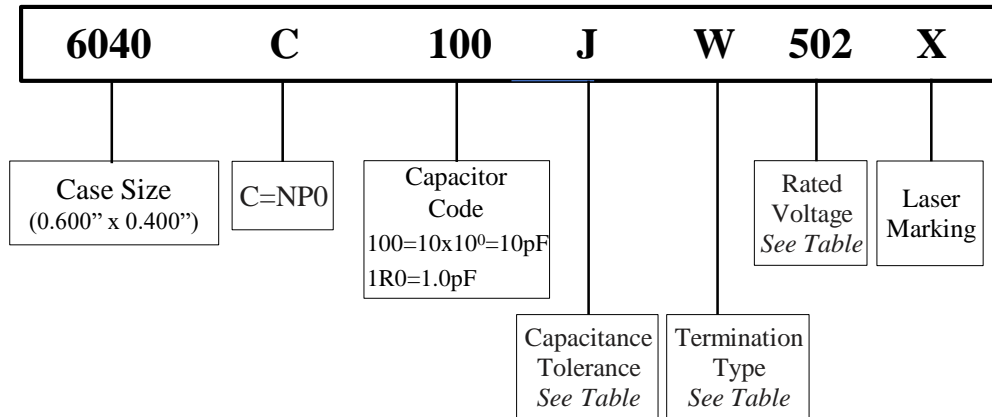

≠ **Capacitance Tolerance Codes**

Code	B	C	D	F	G	J	K
Tol.	±0.1pF	±0.25pF	±0.5pF	±1%	±2%	±5%	±10%

≠ **Voltage Codes**

Voltage	Code
1000V	102
2000V	202
3000V	302
5000V	502
8000V	802



UHF/RF High-Q Power Transmitter
Multi-Layer Ceramic Capacitors

6040C (0.600" x 0.400")

± 6040C Capacitance Values

For special capacitances, tolerances and WVDC, please contact PPI.



Marking shown for illustration purposes only.
Actual marking may differ.

Cap. pF	Cap Code	Tol.	Rated WVDC		Cap. pF	Cap Code	Tol.	Rated WVDC		Cap. pF	Cap Code	Tol.	Rated WVDC	
			Std.	Ext.				Std.	Ext.				Std.	Ext.
1.0	1R0	B,C, D	5000V	8000V	39	390	F,G, J,K	5000V	8000V	1500	152	F,G, J,K	2000V	3000V
1.2	1R2				47	470				1800	182			
1.5	1R5				56	560				2200	222			
1.8	1R8				68	680				2700	272			
2.2	2R2				82	820				3300	332			
2.7	2R7				100	101				4700	472			
3.3	3R3				120	121				5100	512			
3.9	3R9				150	151				5600	562			
4.7	4R7				180	181				6800	682			
5.6	5R6				220	221								
6.8	6R8	F,G, J,K	5000V	8000V	270	271	F,G, J,K	3000V	5000V					
8.2	8R2				330	331								
10	100				390	391								
12	120				470	471								
15	150				560	561								
18	180				680	681								
22	220				820	821				F,G, J,K	2000V	3000V		
27	270				1000	102								
33	330				1200	122								

≠ Termination Types and Codes

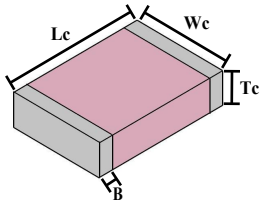

Chip Termination:
Codes: **W, L, P**

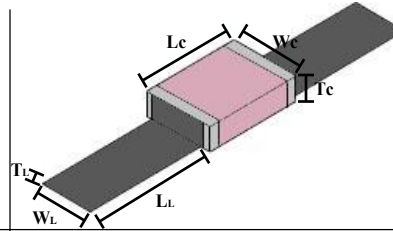

Microstrip Termination:
Codes: **MS, MN**

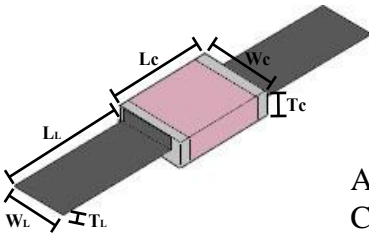

Axial Ribbon Termination:
Code: **AR, AN**

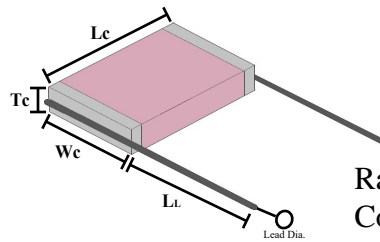

Radial Wire Termination:
Codes: **RW, RN**

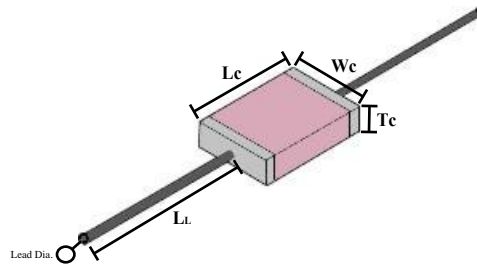

Axial Wire Termination:
Codes: **AW, BN**

Termination Code	Magnetic Termination	Termination Code	Non-Magnetic
W	100% Tin Solder over Nickel Barrier	P	100% Tin Solder over Copper Barrier
L	90%Tin/10%Lead Solder over Nickel Barrier	MN	Silver-Plated Copper
MS		AN	
AR		RN	
RW	Silver-Plated Copper	BN	
AW		Note: "Non-Magnetic" means no magnetic materials.	



≠ **Dimensions** - For Termination Types images, see previous page

Unit: inch (millimeter)

Magnetic Termination								
Code		Capacitor Dimensions				Lead Dimensions		
		Length	Width	Thickness	Overlap	Length	Width	Thickness
		Lc	Wc	Tc	B	LL	WL	TL
W/L	Chip	0.614 (15.6)	$\begin{matrix} +0.015 \\ -0.010 \\ +0.38 \\ -0.25 \end{matrix}$	0.433 ± 0.010 (11.0 ± 0.25)	0.154 ± 0.008 (3.90 ± 0.20)	0.063 max (1.60 max)	-	-
MS	Microstrip					0.787 min (20.0 min)	0.350 ± 0.010 (8.89 ± 0.50)	0.008 ± 0.001 (0.20 ± 0.025)
AR	Axial Ribbon	0.614	$\begin{matrix} +0.015 \\ -0.010 \end{matrix}$	0.433 ± 0.010	0.154 ± 0.008	0.787 min (20.0 min)	0.350 ± 0.010 (8.89 ± 0.50)	0.008 ± 0.001 (0.20 ± 0.025)
RW	Radio Wire	(15.6)	$\begin{matrix} +0.38 \\ -0.25 \end{matrix}$	(11.0 ± 0.25)	(3.90 ± 0.20)	0.787 min (20.0 min)	Dia. = 0.030 ± 0.004	
AW	Axial Wire					0.984 min (25.00 min)	Dia. = (0.80 ± 0.10)	

Non-Magnetic Termination								
Code		Capacitor Dimensions				Lead Dimensions		
		Length	Width	Thickness	Overlap	Length	Width	Thickness
		Lc	Wc	Tc	B	LL	WL	TL
P	Chip	0.614 (15.6)	$\begin{matrix} +0.015 \\ -0.010 \\ +0.38 \\ -0.25 \end{matrix}$	0.433 ± 0.010 (11.0 ± 0.25)	0.154 ± 0.008 (3.90 ± 0.20)	0.063 max (1.60 max)	-	-
MN	Microstrip					0.787 min (20.0 min)	0.350 ± 0.010 (8.89 ± 0.50)	0.008 ± 0.001 (0.20 ± 0.025)
AN	Axial Ribbon	0.614	$\begin{matrix} +0.015 \\ -0.010 \end{matrix}$	0.433 ± 0.010	0.154 ± 0.008	0.787 min (20.0 min)	0.350 ± 0.010 (8.89 ± 0.50)	0.008 ± 0.001 (0.20 ± 0.025)
RN	Radio Wire	(15.6)	$\begin{matrix} +0.38 \\ -0.25 \end{matrix}$	(11.0 ± 0.25)	(3.90 ± 0.20)	0.787 min (20.0 min)	Dia. = 0.030 ± 0.004	
BN	Axial Wire					0.984 min (25.00 min)	Dia. = (0.80 ± 0.10)	

⊘ Note: Non-Magnetic means no magnetic materials. All leads are attached with high temperature solder and parts are RoHS Compliant.



≠ Electrical Specifications

Quality Factor (Q)	No less than 1000pF, Q value more than 2000, Test Frequency 1MHz; More than 1000pF, Q value more than 2000, Test Frequency 1MHz
Insulation Resistance (IR)	Test Voltage: 500V 10 ⁵ Megaohms min. @ +25°C 10 ⁴ Megaohms min. @ +125°C
Rated Voltage	See Rated Voltage in Capacitance Table
Dielectric Withstanding Voltage (DWV)	250% of Voltage of 5 seconds, Rated Voltage ≤ 500VDC 150% of Voltage for 5 seconds, 500VDC < Rated Voltage ≤ 1250 VDC 120% of Voltage for 5 seconds, Rated Voltage > 1250 VDC
Operating Temperature Range	-55°C to 175°C
Temperature Coefficient (TC)	-55°C to 125°C 0±30ppm/°C >125°C to 175°C 0±60ppm/°C
Capacitance Drift	±0.02% or ±0.02pF, whichever is greater
Piezoelectric Effects	None
Termination Type	See Termination Type Table

≠ Environmental Specifications

	Specification	Test Parameters
Thermal Shock	DWV: The initial value IR: Shall not be less than 30% of the initial value. Capacitance Change:	MIL-STD-202, Method 107, Condition A. At the maximum rated temperature (-55°C and 175°C) stay 30 minutes, the time of removing shall not be more than 3 minutes. Perform five cycles.
Moisture Resistance	No more than 0.5% or 0.5pF, whichever is greater.	MIL-STD-202, Method 106
Humidity (Steady State)	DWV: The initial value IR: The initial value Capacitance Change: No more than 0.3% or 0.3pF, whichever is greater.	MIL-STD-202, Method 103, Condition A With 1.5Volts DC applied while subjected to an environment of 85°C with 85% relative humidity for 240 hours minimum.
Life	IR: Shall not be less than 30% of the initial value. Capacitance Change: No more than 2.0% or 0.5pF, whichever is greater.	MIL-STD-202, Method 108. For 2000 hours, at 125°C. 200% of Voltage for Capacitors, Rated Voltage ≤ 500VDC; 120% of Voltage for Capacitors, 500VDC < Rated Voltage ≤ 1250VDC; 100% for Voltage for Capacitors, Rated Voltage > 1250VDC
Terminal Strength	Force: 25lbs typical, 20lbs. min. Duration Time: 5 to 10 seconds	MIL-STD-202, Method 211A, Test Condition A. Applied a force and maintained for a period of 5 to 10 seconds. The force shall be in the direction of the axes of the terminations.

Capacitors are designed and manufactured to meet the requirements of MIL-PRF-55681 and MIL-PRF-123.



≠ ESR vs. Capacitance Measured @ 30MHz

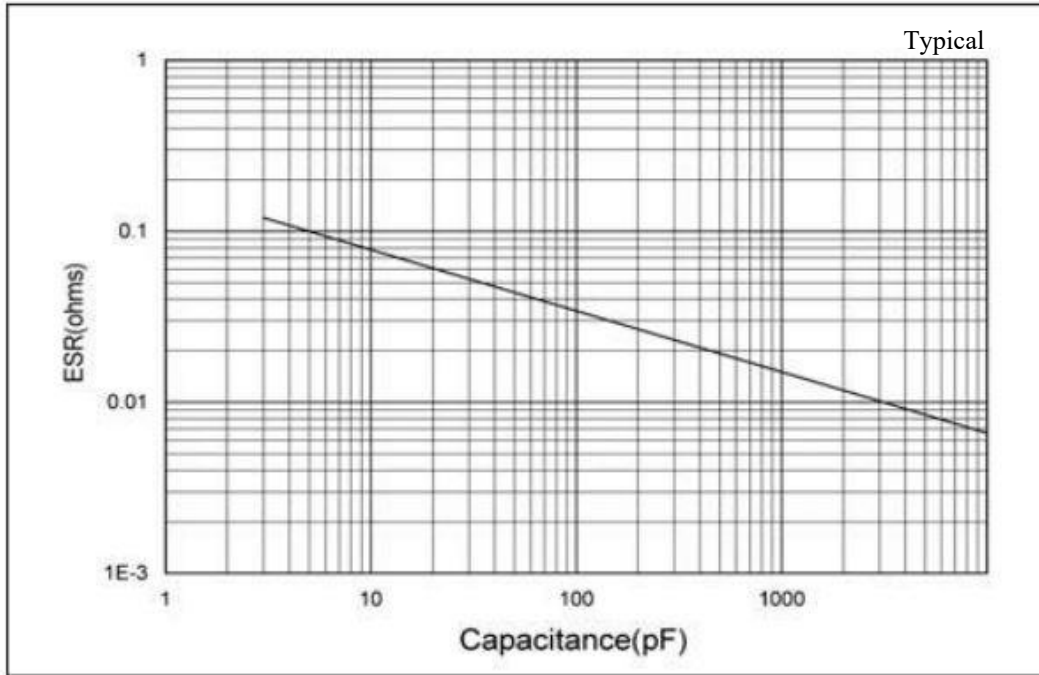

≠ Self Resonant Frequency vs. Capacitance

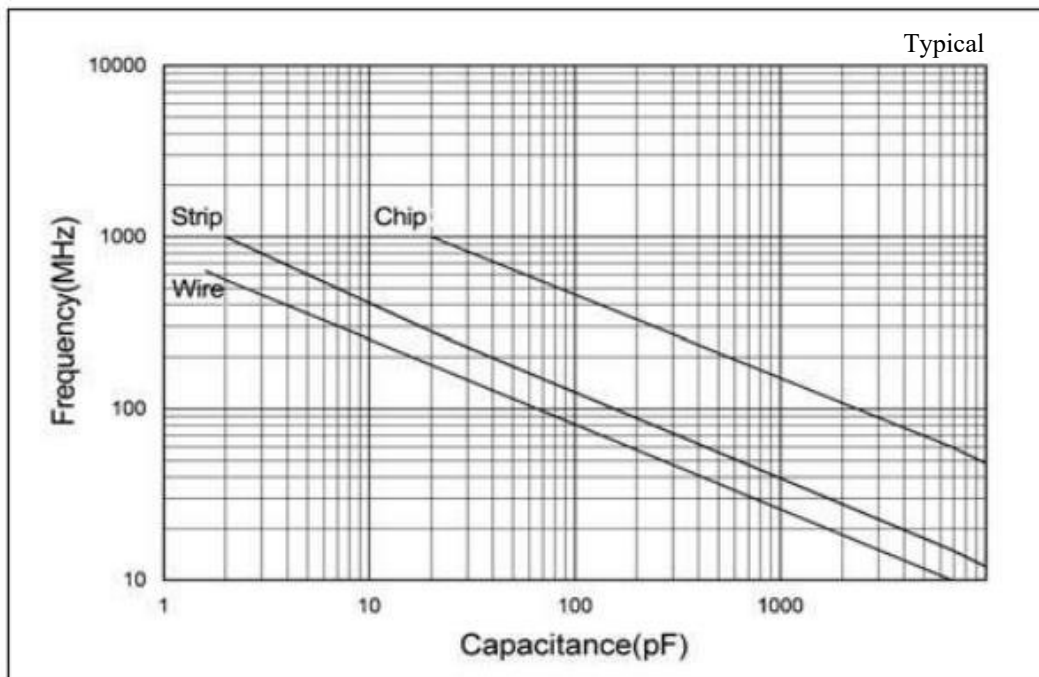

≠ Strip Terminals Rated Current vs. Frequency

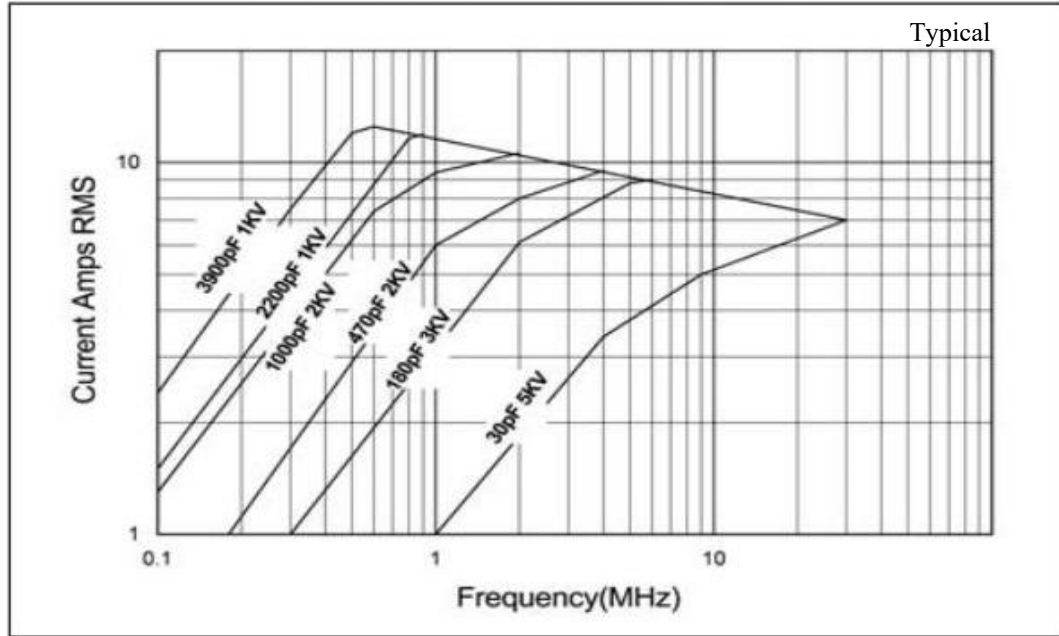

≠ Wire Terminals Rated Current vs. Frequency

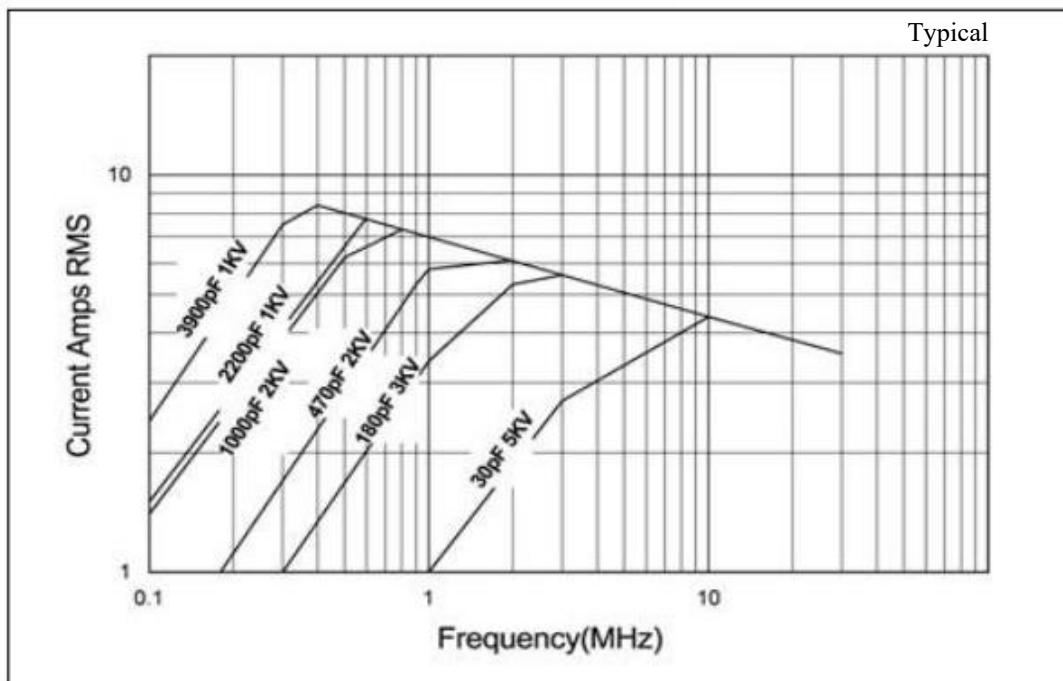

≠ % Maximum Current vs. Ambient Temperature

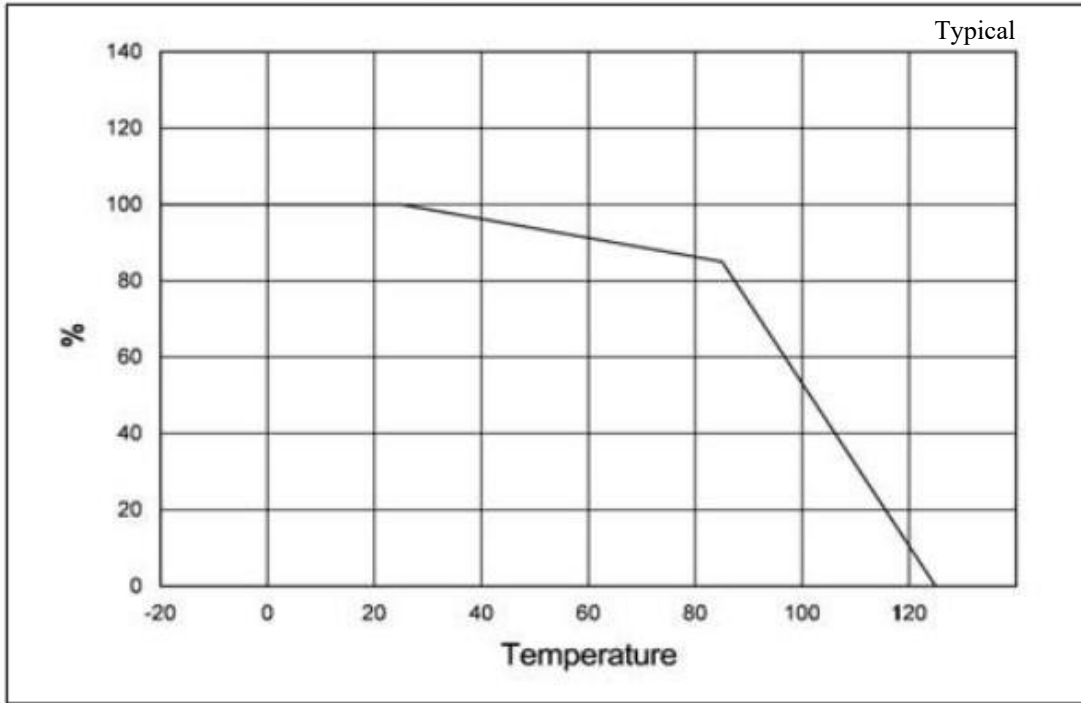

≠ Recommended Land Pattern Dimensions

Regarding Landing Patterns, please refer to IPC-7351B (table 3-5, 3-6).

≠ Custom Assemblies

Passive Plus offers Capacitor Assemblies for high power requirements. Typical assemblies are configured in series and/or parallel combinations, producing higher voltage/current handling capabilities, extended capacitance range and tighter tolerances.

To get started, simply send us either a mechanical drawing or circuit conditions and we can recommend a solution. All components are 100% up-screened for Partial Discharge and Sonoscanned. All assemblies include a 100hr Military burn in.

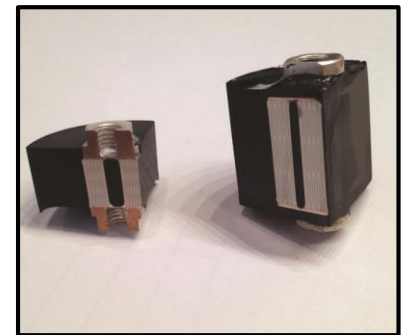



≠ **Product Features**

- High Q
- High RF Current/Voltage
- Ultra Stable Performance
- Capacitance Range:
1.0pF to 20000pF
- Working Voltage: 5000V
- Extended Voltage: 8000V

≠ **Typical Circuit Applications**

- Semiconductor Manufacturing
- High Energy Power Transfers
- Plasma Chambers
- Medical Equipment



Marking shown for illustration purposes only.
Actual marking may differ.

≠ **Part Numbering**

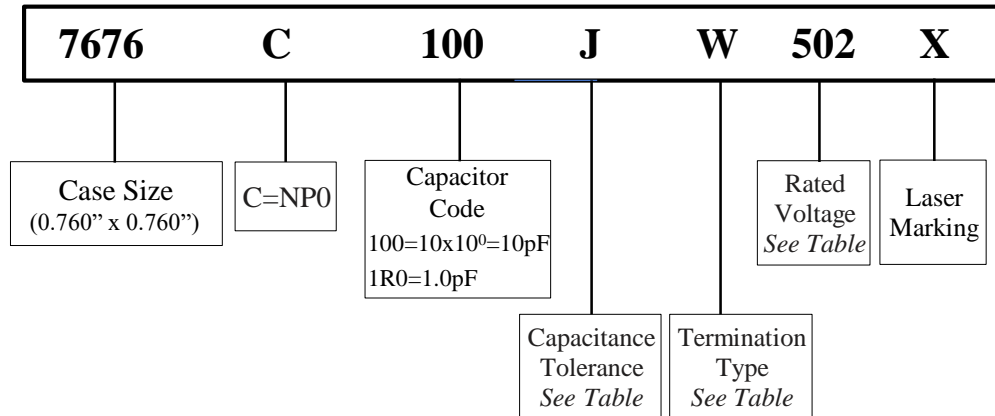

≠ **Capacitance Tolerance Codes**

Code	B	C	D	F	G	J	K
Tol.	±0.1pF	±0.25pF	±0.5pF	±1%	±2%	±5%	±10%

≠ **Voltage Codes**

Voltage	Code
1000V	102
2000V	202
3000V	302
5000V	502
8000V	802



≠ 7676C Capacitance Values

Special capacitances, tolerances and WVDC are available. Please contact PPI.

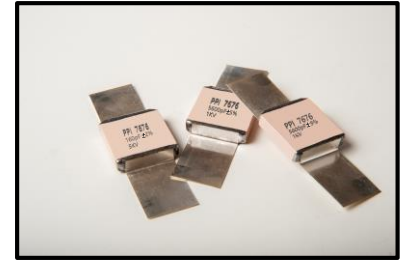

Marking shown for illustration purposes only.
Actual marking may differ.

Cap. pF	Cap Code	Tol.	Rated WVDC		Cap. pF	Cap Code	Tol.	Rated WVDC		Cap. pF	Cap Code	Tol.	Rated WVDC	
			Std.	Ext.				Std.	Ext.				Std.	Ext.
1.0	1R0	B,C, D	5000V	8000V	33	330	F,G, J,K	5000V	8000V	1000	102	G,J, K	3000V	5000V
1.2	1R2				39	390				1200	122			
1.5	1R5				47	470				1500	152			
1.8	1R8				56	560				1800	182			
2.2	2R2				68	680				2200	222			
2.7	2R7				82	820				2700	272			
3.3	3R3				100	101				3300	332			
3.9	3R9				120	121				4700	472			
4.7	4R7				150	151				5100	512			
5.6	5R6				180	181				5600	562			
6.8	6R8	220	221	6800	682	G,J, K	1000V	3000V						
8.2	8R2	270	271	7500	752									
10	100	F,G, J,K	5000V	8000V	300	301	F,G, J,K	3000V	5000V	8200	822	G,J, K	1000V	2000V
12	120				390	391				10000	103			
15	150				470	471				12000	123			
18	180				560	561				15000	153			
22	220				680	681				18000	183			
27	270				820	821				20000	203			

≠ Termination Types and Codes

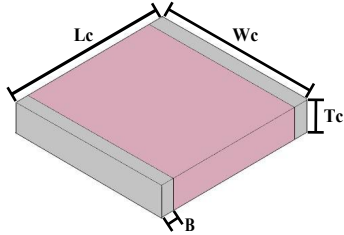

Chip Termination:
Codes: **W, L, P**

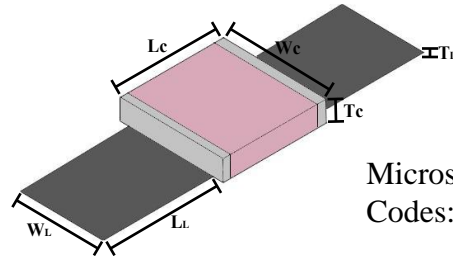

Microstrip Termination:
Codes: **MS, MN**

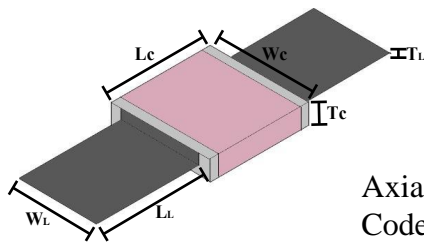



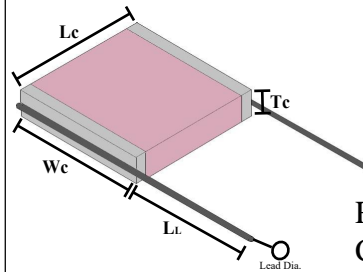

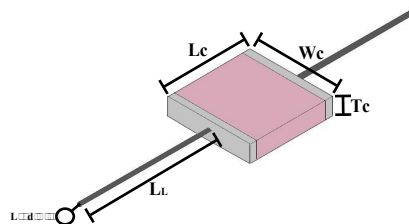

Axial Ribbon Termination:
Code: **AR, AN**









Radial Wire Termination:
Codes: **RW, RN**



Axial Wire Termination:
Codes: **AW, BN**

Termination Code	Magnetic Termination
W 	100% Tin Solder over Nickel Barrier
L 	90%Tin/10%Lead Solder over Nickel Barrier
MS 	
AR 	
RW 	Silver-Plated Copper
AW 	

Termination Code	Non-Magnetic  Termination
P 	100% Tin Solder over Copper Barrier
MN 	
AN 	
RN 	Silver-Plated Copper
BN 	

 Note: "Non-Magnetic" means no magnetic materials.



≠ Dimensions - For Termination Types images, see previous page Unit: inch (millimeter)

		Magnetic Termination					Lead Dimensions		
Code		Capacitor Dimensions			Overlap	Length	Width	Thickness	
		Length	Width	Thickness					
		Lc	Wc	Tc	B	LL	WL	TL	
W/L	Chip	0.760 (19.3)	0.760 ± 0.010 (19.3 ± 0.25)	0.197 max (5.00 max)	0.024 ~ 0.059 (0.60 ~ 1.50)	-	-	-	
MS	Microstrip					0.748 min (19.0 min)	0.591 ± 0.010 (15.00 ± 0.25)	0.008 ± 0.001 (0.20 ± 0.025)	
AR	Axial Ribbon	0.760 (19.3)	0.760 ± 0.010 (19.3 ± 0.25)	0.197 max (5.00 max)	-	0.748 min (19.0 min)	0.591 ± 0.010 (15.00 ± 0.25)	0.008 ± 0.001 (0.20 ± 0.025)	
RW	Radio Wire					0.748 min (19.0 min)			
AW	Axial Wire					0.906 min (23.00 min)			
							Dia. = 0.031 ± 0.006 Dia. = (0.80 ± 0.15)		

		Non-Magnetic Termination					Lead Dimensions		
Code		Capacitor Dimensions			Overlap	Length	Width	Thickness	
		Length	Width	Thickness					
		Lc	Wc	Tc	B	LL	WL	TL	
P	Chip	0.760 (19.3)	0.760 ± 0.010 (19.3 ± 0.25)	0.197 max (5.00 max)	0.024 ~ 0.059 (0.60 ~ 1.50)	-	-	-	
MN	Microstrip					0.748 min (19.0 min)	0.591 ± 0.010 (15.00 ± 0.25)	0.008 ± 0.001 (0.20 ± 0.025)	
AN	Axial Ribbon	0.760 (19.3)	0.760 ± 0.010 (19.3 ± 0.25)	0.197 max (5.00 max)	-	0.748 min (19.0 min)	0.591 ± 0.010 (15.00 ± 0.25)	0.008 ± 0.001 (0.20 ± 0.025)	
RN	Radio Wire					0.748 min (19.0 min)			
BN	Axial Wire					0.906 min (23.00 min)			
							Dia. = 0.031 ± 0.006 Dia. = (0.80 ± 0.15)		

⊗ Note: Non-Magnetic means no magnetic materials. All leads are attached with high temperature solder and parts are RoHS Compliant.



≠ Electrical Specifications

Quality Factor (Q)	No less than 1000pF, Q value more than 2000, Test Frequency 1MHz; More than 1000pF, Q value more than 2000, Test Frequency 1kHz
Insulation Resistance (IR)	Test Voltage: 500V 10 ⁵ Megaohms min. @ +25°C 10 ⁴ Megaohms min. @ +125°C
Rated Voltage	See Rated Voltage in Capacitance Table
Dielectric Withstanding Voltage (DWV)	250% of Voltage of 5 seconds, Rated Voltage ≤ 500VDC 150% of Voltage for 5 seconds, 500VDC < Rated Voltage ≤ 1250 VDC 120% of Voltage for 5 seconds, Rated Voltage > 1250 VDC
Operating Temperature Range	-55°C to 175°C
Temperature Coefficient (TC)	-55°C to 125°C 0±30ppm/°C >125°C to 175°C 0±60ppm/°C
Capacitance Drift	±0.2% or ±0.05pF, whichever is greater
Piezoelectric Effects	None
Termination Type	See Termination Type Table

≠ Environmental Specifications

	Specification	Test Parameters
Thermal Shock	DWV: The initial value IR: Shall not be less than 30% of the initial value. Capacitance Change:	MIL-STD-202, Method 107, Condition A. At the maximum rated temperature (-55°C and 175°C) stay 30 minutes, the time of removing shall not be more than 3 minutes. Perform five cycles.
Moisture Resistance	No more than 0.5% or 0.5pF, whichever is greater.	MIL-STD-202, Method 106
Humidity (Steady State)	DWV: The initial value IR: The initial value Capacitance Change: No more than 0.3% or 0.3pF, whichever is greater.	MIL-STD-202, Method 103, Condition A With 1.5Volts DC applied while subjected to an environment of 85°C with 85% relative humidity for 240 hours minimum.
Life	IR: Shall not be less than 30% of the initial value. Capacitance Change: No more than 2.0% or 0.5pF, whichever is greater.	MIL-STD-202, Method 108. For 2000 hours, at 125°C. 200% of Voltage for Capacitors, Rated Voltage ≤ 500VDC; 120% of Voltage for Capacitors, 500VDC < Rated Voltage ≤ 1250VDC; 100% for Voltage for Capacitors, Rated Voltage > 1250VDC
Terminal Strength	Force: 30lbs. min. Duration Time: 5 to 10 seconds	MIL-STD-202, Method 211A, Test Condition A. Applied a force and maintained for a period of 5 to 10 seconds. The force shall be in the direction of the axes of the terminations.

Capacitors are designed and manufactured to meet the requirements of MIL-PRF-55681 and MIL-PRF-123.

≠ ESR vs. Capacitance Measured @ 30MHz

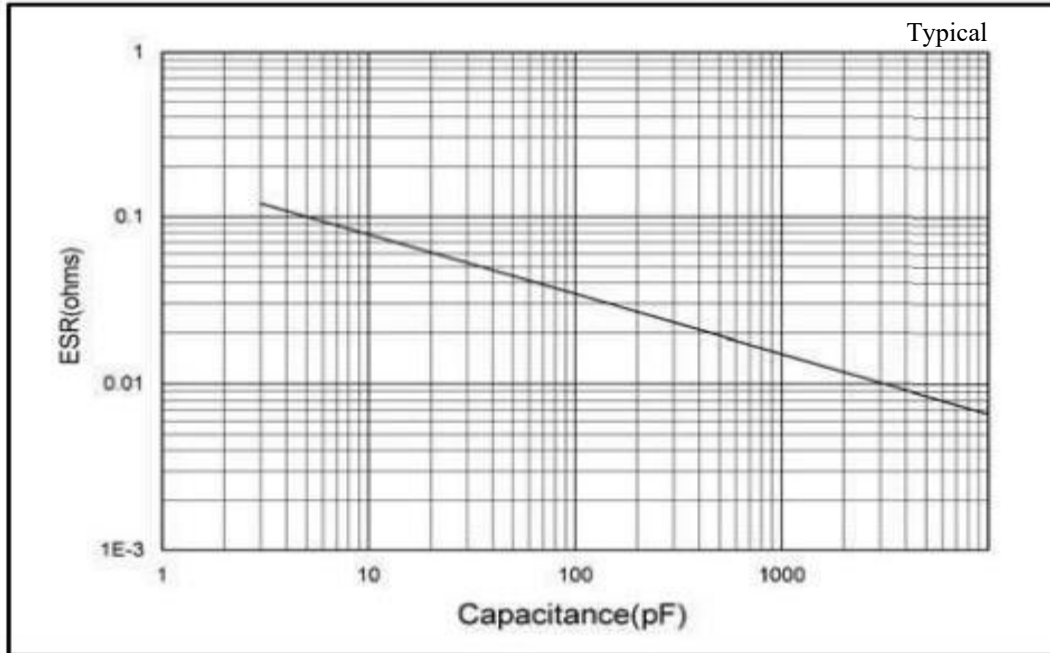

≠ Self Resonant Frequency vs. Capacitance

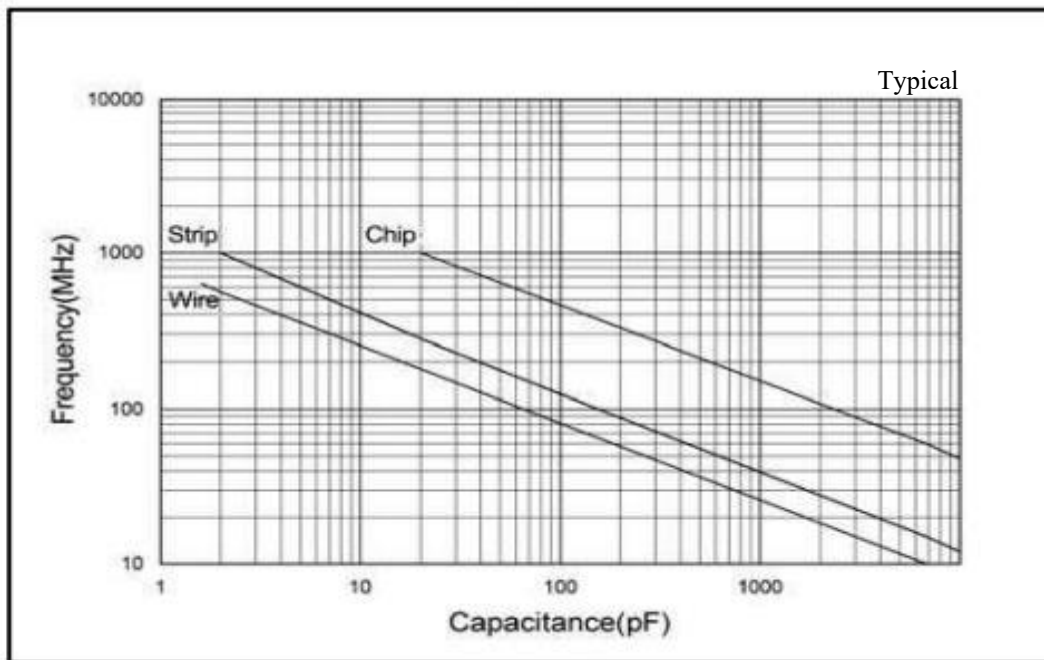

≠ Strip Terminals Rated Current vs. Frequency

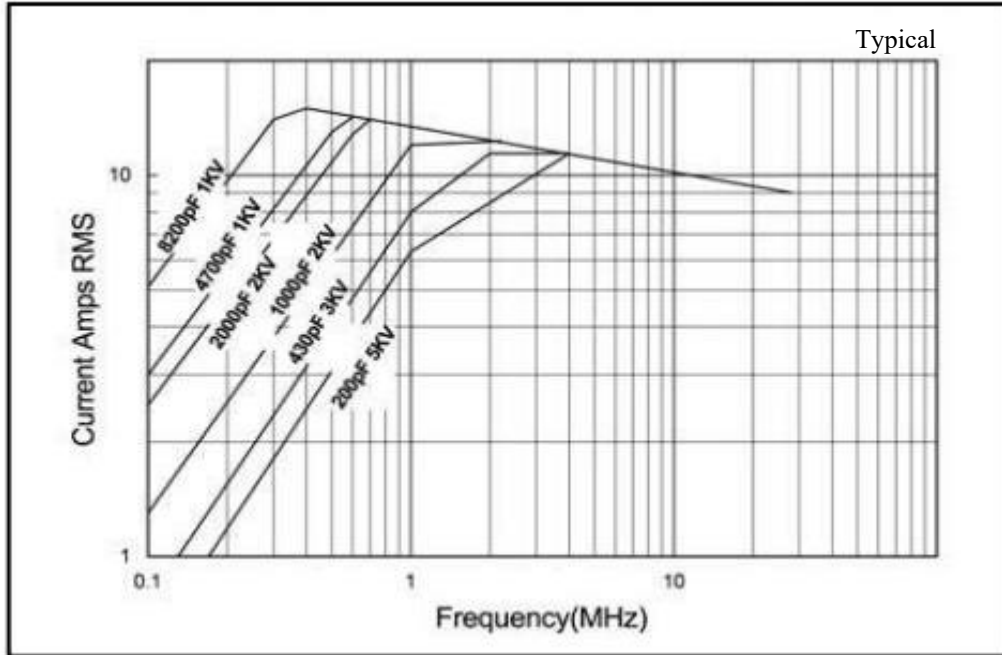

≠ Wire Terminals Rated Current vs. Frequency

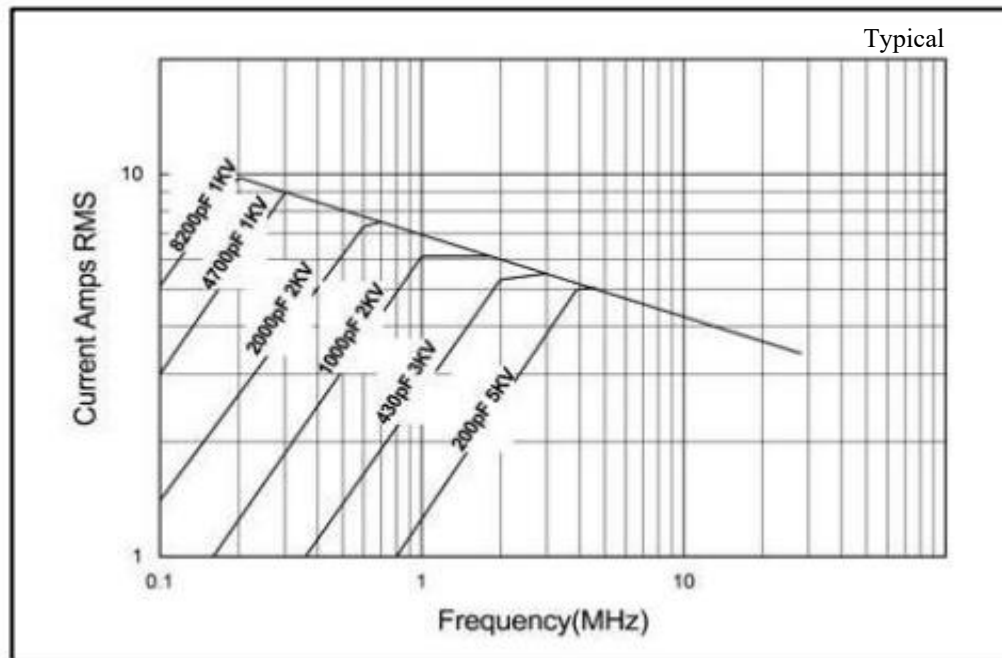

≠ % Maximum Current vs. Ambient Temperature

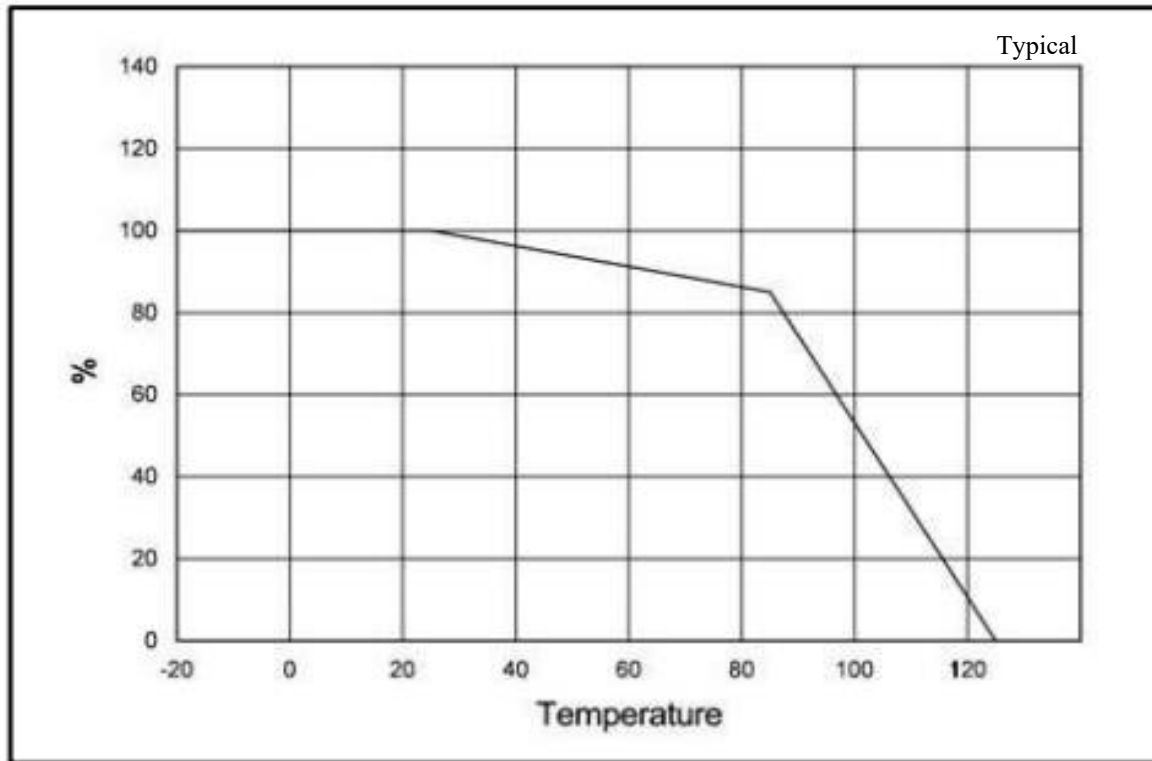

≠ Recommended Land Pattern Dimensions

Regarding Landing Patterns, please refer to IPC-7351B (Table 3-5, 3-6).

≠ Custom Assemblies

Passive Plus offers Capacitor Assemblies for high power requirements. Typical assemblies are configured in series and/or parallel combinations, producing higher voltage/current handling capabilities, extended capacitance range and tighter tolerances.

To get started, simply send us either a mechanical drawing or circuit conditions and we can recommend a solution. All components are 100% up-screened for Partial Discharge and Sonoscanned. All assemblies include a 100hr Military burn in.

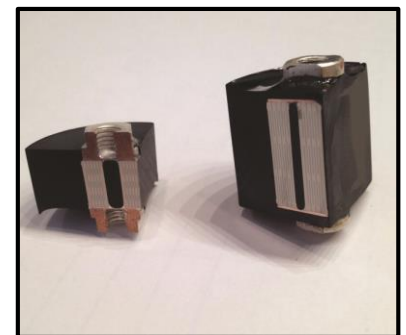



UHF/RF High-Q Power Transmitter
Multi-Layer Ceramic Capacitors

Custom Capacitor Assemblies

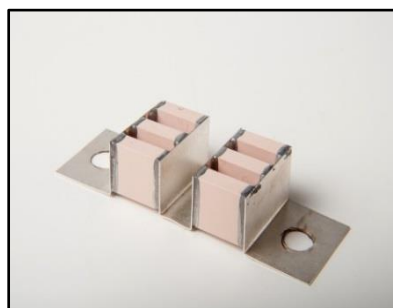
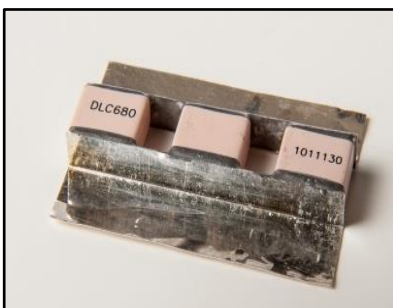
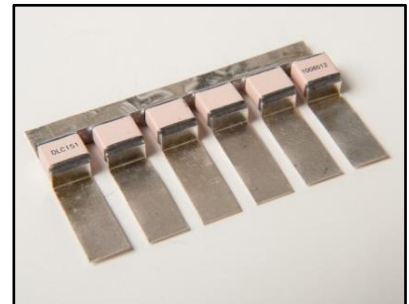
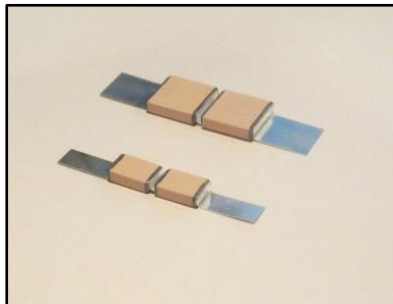

*Marking shown for illustration purposes only.
Actual marking may differ.*

Please contact PPI (sales@passiveplus.com) to discuss custom assembly options.



≠ Product Features

High Operating Voltage, High Operating Current, Extended Capacitance,
Tighter Tolerances, High Reliability, High Q, Ultra-low ESR, Non-Magnetic

≠ Typical Applications Field

High Power RF, Medical Electronics, Broadcast, Semiconductor Manufacturing,
High Magnetic Environments, Inductive Heating

≠ Part Numbering



*Marking shown for illustration purposes only.
Actual marking may differ.*

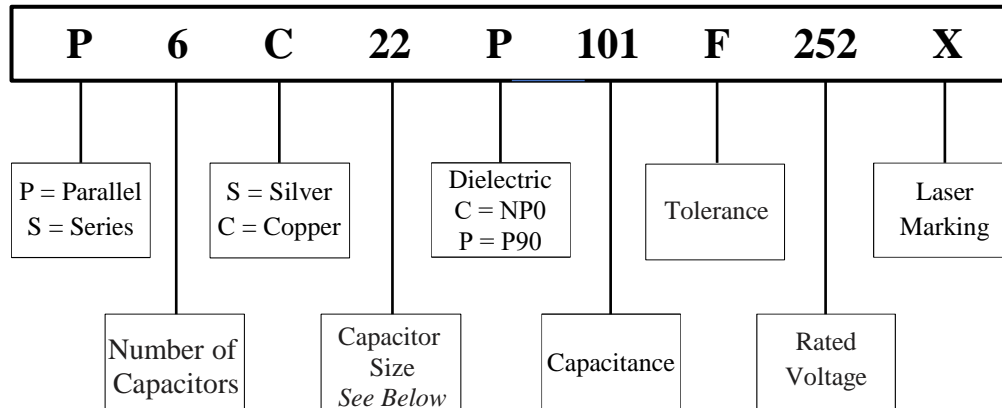

Capacitor Size:

11 = 1111; 22 = 2225; 38 = 3838; 60 = 6040; 76 = 7676

Capacitance: For capacitor values requiring 3 significant digits,

e.g. 1222.5pF =1222R5

e.g. P6S22P101F252X

Silver bracket assembly with six 2225C pieces in parallel, Capacitance is 100pF,

Capacitance tolerance is ±1%, WVDC is 2500 V and Laser marking.

e.g. S2S25C1222R5G203X

Silver bracket assembly with two 2225C pieces in series, Capacitance is 1222.5pF,

Capacitance tolerance is ±2%, WVDC is 20,000V and Laser marking.

≠ Capacitance and Voltage

By Buyer's requirements using existing drawings, mechanical sketches, or we can help with capable modeling of assemblies thermal rise predictions.



≠ Typical Assembly Configurations

≠ Parallel Assemblies

unit:inch (millimeter)

	1111C/P	2225C/P	3838C/P	6040C	7676C
Lead Material	Silver plated Copper or Silver				
Lead Thickness	.004 or .010 (0.1 or 0.25)			.010 or .020 (0.25 or 0.51)	
Lead Length (max.)	.50 (12.7)	.75 (19.8)		2.0 (50.8)	
Capacitor Spacer (typ.)	.050 or .078 (1.3 or 2)			.090 (2.3)	.050 or .157 (1.3 or 4)
Mounting Configuration	Horizontal / Vertical				

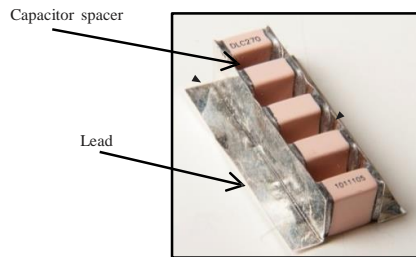

3838 Series/Parallel Combination

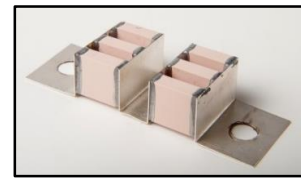

Marking shown for illustration purposes only. Actual marking may differ.

≠ Series Assemblies

unit:inch (millimeter)

	2225C/P	3838C/P	6040C	7676C
Lead Type	L Bracket			
Lead Material	Silver plated Copper or Silver			
Lead Thickness	.010 (0.25)		.010 or .020 (0.25 or 0.51)	
Lead Length (max.)	.75 (19.8)	1.0 (25.4)		
Capacitor Spacer (typ.)	.050 or .157 (1.3 or 4)			
Mounting Configuration	Horizontal			

- Epoxy Molding Available

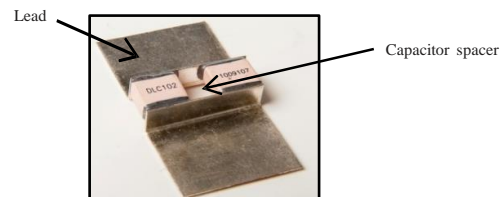

Marking shown for illustration purposes only. Actual marking may differ.

Other Assemblies: By Buyer's requirement. Contact PPI.

Marking shown for illustration purposes only.
Actual marking may differ.

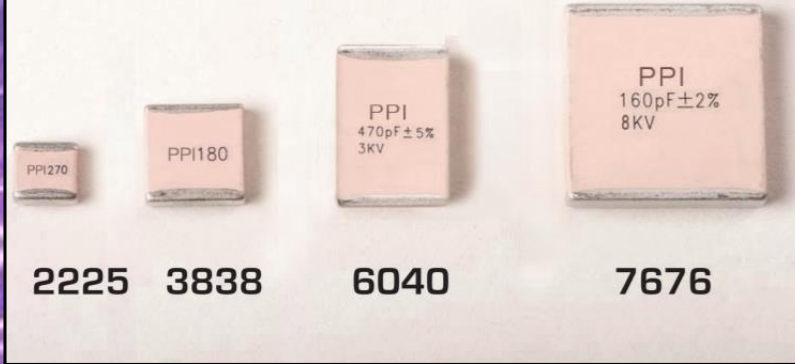

PPI Passive Plus
RF & Microwave Components
Headquarters: New York, USA

